



AIRAM

Koristevalot | Dekorationsbelysning | Decorative Lights
Kevät | Vår | Spring 2019

AIRAM



Airam Electric Oy Ab
Sementtitehtaankatu 6
04260 Kerava
vaihte 0207 545 600
www.airam.fi

Postiosoite:
Airam Electric Oy Ab
PL 175
04201 Kerava

Airam AB
Uppköparvägen 7
120 44 Årsta, Sverige
Telefon +46 8 72 244 20
(växel)
Fax +46 8 60 283 00
info@airam.se
www.airam.se

Airam Electric Oy Ab
P.O. Box 175
(Sementtitehtaankatu 6)
FI-04201 Kerava
Finland
Tel. +358 207 545 600
fax +358 207 545 623
export@airam.fi
www.airam.fi

TEAM FINLAND

Tilaukset sähköpostitse
Tilaukset faksilla
Tilaukset / Asiakaspalvelu

0207 545 624
0207 545 617

tilaukset@airam.fi

asiakaspalvelu@airam.fi

Tilaukset / Asiakaspalvelu
Tilaukset / Asiakaspalvelu
Tilaukset / Asiakaspalvelu

Kristiina Juvonen
Anette Juvonen
Tiina Vahtera-Jäppilä

0207 545 613
0207 545 622
0207 545 615

kristiina.juvonen@airam.fi
anette.juvonen@airam.fi
tiina.vahtera-jappila@airam.fi

Myyntijohtaja PT
PT avainasiakkaat Etelä- ja Länsi-Suomi
PT avainasiakkaat Itä- ja Pohjois-Suomi
PT Etelä-Suomi
PT Länsi-Suomi
PT Pohjois-Suomi
PT myyntiassistentti

Kari Niemenmaa
Ari Tihinen
Keijo Tikkanen
Kalle Rautio
Taneli Leppäniemi
Pekka Järvelä
Sanna Helenius

0400 729 408
040 745 6142
040 508 3908
040 132 5442
044 738 9794
0400 461 181
0400 229 140

kari.niemenmaa@airam.fi
ari.tihinen@airam.fi
keijo.tikkanen@airam.fi
kalle.rautio@airam.fi
taneli.leppaniemi@airam.fi
pekka.jarvela@airam.fi
sanna.helenius@airam.fi

Markkinointijohtaja
Kuvat ja myymälämateriaali
Reklamaatiot/laadunvalvonta

Minna Hellström
Tuula Tujula

040 802 1076
040 551 4962

minna.hellstrom@airam.fi
mediabank.airam.fi
asiakaspalaute@airam.fi

TEAM SVERIGE

VD

Niclas Steén

+46 8 722 44 20

niclas.steen@airam.se

Kundtjänst
Kundtjänst

Monica Larsson
Lina Vitulic

+46 70 263 74 44
+46 8 722 44 20

monica.larsson@airam.se
lina.vitulic@airam.se

Kundtjänst/ allmänna frågor &
information

+46 8 722 44 20

info@airam.se

Säljteam
Säljteam
Säljteam
Säljteam
Säljteam
Säljteam

Joakim Karlsson
Lennart Andersson
Gerry Glyré
Lars Landgren
Magnus Siljedahl
Jesper Vikberg

+46 73 088 66 11
+46 70 593 07 49
+46 70 826 99 00
+46 79 341 02 92
+46 70 360 23 95
+46 70 567 64 34

joakim.karlsson@airam.se
lennart.andersson@airam.se
gerry.glyre@airam.se
lars.landgren@airam.se
magnus.siljedahl@airam.se
jesper.vikberg@airam.se

TEAM EXPORT

Customer service
Sales
Sales

Marika Jääskeläinen
Kalle Kärki

+358 40 658 2170
+358 40 635 2175

export@airam.fi
marika.jaaskelainen@airam.fi
kalle.karki@airam.fi



SOLAR-SARJAT/ SOLCELLS-SERIER/
SOLAR SERIES

| | |
|-------|---|
| Opole | 4 |
| Kesä | 5 |
| Hanna | 6 |

SOLAR-LYHDYT/ SOLCELLS-LYKTOR/
SOLAR LANTERNS

| | |
|--------|-------|
| Kenji | 7 |
| Eriko | 7 |
| Rocky | 8 |
| Apollo | 9 |
| Malik | 10 |
| Alpi | 11 |
| Dani | 12-13 |
| Nemo | 14 |
| Palmer | 15 |
| Lucy | 16 |
| Tioga | 18 |
| Lester | 19 |

SOLAR-HAHMOT/
SOLCELLS-FIGURER/
SOLAR FIGURES

| | |
|--|----|
| Kanto | 20 |
| Grin | 21 |
| Karhu/ Björn/ Bear | 22 |
| Panda | 23 |
| Sammakko/ Groda/ Frog | 24 |
| Orava/ Ekorre/ Squirrel | 25 |
| Pöllö/ Uggla/ Owl | 26 |
| Paristoakut/ Laddningsbara batterier/ Rechargeable batteries | 27 |



UUTUUDET/ NYHETER/
NOVELTIES

| | |
|--------|----|
| Elli | 29 |
| Point | 30 |
| Mea | 31 |
| Candy | 32 |
| Paris | 33 |
| Nashua | 34 |
| Norte | 35 |
| Neptus | 36 |



4 SEASONS LANKAPALLOT/
BOMULLSBOLLAR/
COTTON BALLS

| | |
|-----------------|----|
| Minni 20 | 39 |
| Milja 10 | 40 |
| Milja 20 | 41 |
| Milja 6 Ø 15 cm | 42 |
| Milja 6 Ø 20 cm | 43 |

4 SEASONS VALOLANGAT/
DEKORATIONSSLINGOR/
LIGHT WIRES

| | |
|---|-------|
| Nappi | 44 |
| 4 Seasons LED valolankasarjat/ dekorationslingor/ Light wires | 45 |
| Niili | 46 |
| Saana | 48-49 |



4 SEASONS KÖYDET/ REPPRODUKTER/
PRODUCTS OF ROPE

| | |
|--------|----|
| Eimi | 50 |
| Rita | 51 |
| Gen | 52 |
| Paloma | 53 |

4 SEASONS LAMPPUSARJAT/
LAMPSSLINGOR/ LIGHT SETS

| | |
|-----------------------------------|----|
| Jardin | 54 |
| Keira | 56 |
| Kajo | 57 |
| Huvi | 58 |
| Tallilyhty/ Oljelykta/ Lantern | 59 |

Symbolit/ Symboler/ Symbols



Blister*



4 Seasons varastotuote/
finns i lager/ in stock



Vaihtaa väriä/ Byter färg/
Changing colour



Ajastin/ Timer



Box*



Sisäkäyttöön/
För inomhusbruk/
For indoor use



Eläväl liekki/ Levande låga/
Living flame



Hämäräkytkin/
Skymningssensor/
Dusk Switch



Pöytä-/Bord-/
Table display*



Ulkokäyttöön/
För utomhusbruk/
For outdoor use



Paristot/ Batterier/
Batteries**



Polttoikä/ Brinntid/
Burning hours



Uutuus/Nyhet/New



LED (kpl/ st/ pcs)



Muuntaja/ Transformer/
Driver



Varalamppu/
Reservlampa/
Spare bulb



Solar LED



Valon sävy/ Ljus nyans/
Shade of light



USB
** + Määrä ja tyyppi/
mängd och typ/ amount and type



Jatkettava/ Länkarhet/
Extendable

* + ME/ FPK/ Sales Unit

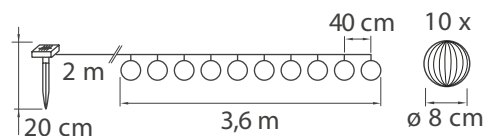

OPOLE

SOLAR LED-SARJA

Solar LED-sarja, jossa 10 kpl kauniita palloja. Led 30 kpl: 3 kpl/pallo, lämmin valkoinen, ei vaihdettava. Mukana vaihdettava ja ladattava paristoakku. Materiaali muovi. Johto kirkas. On/off-kytkin.

LED SOLCELLS-SERIE

En LED solcells-serie med 10 vackra transparenta bollar. 30 st varmvita LED-lampor (3 st/boll), ej utbytbara. Utbytbart och laddningsbart batteri ingår. Tillverkad av plast. Genomskinlig sladd. Av-/på-knapp.

SOLAR LED SERIES

A Solar LED series with 10 beautiful balls. LED 30 pcs: 3 pc/ball, warm white, non-replaceable. Replaceable and rechargeable battery included. Material of plastic. Clear cord. On/off switch.



Nr 9477978



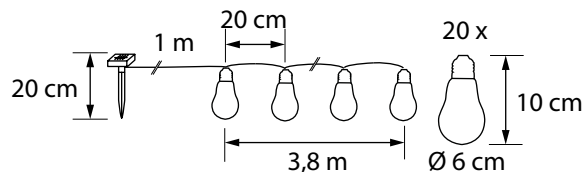

KESÄ

SOLAR LED-SARJA

Solar LED-sarja, jonka saa ripustettua näyttäviin asetelmiin. Lamppusuo-
jissa klassinen hehkulampun muoto. LED lämmin valkoinen,
ei vaihdettava. Mukana vaihdettava ja ladattava paristoakku. Materiaali
muovi. Johto kirkas. On/off-kytkin.

LED SOLCELLS-SERIE

En LED solcells-serie som kan användas för att skapa spännande
kombinationer och former. Lamphöljen i klassisk glödlampform.
Varmvita LED-lampor, ej utbytbara. Utbytbart och laddningsbart batteri
ingår. Tillverkad av plast. Genomskinlig sladd. Av-/på-knapp.

SOLAR LED SERIES

A solar LED series that can be hung in impressive ways and
combinations. The spheres have the classic bulb shape. LED warm
white, non-replaceable. Replaceable and rechargeable battery included.
Material of plastic. Clear cord. On/off switch.



Nr 9477809



6 435200 217189



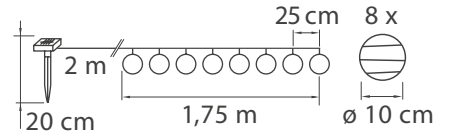

HANNA

SOLAR-PALLOSARJA

Itse koottava solar-sarja, jossa valkoiset ja harmaat pallot. LED lämmin valkoinen, ei vaihdettava. Mukana vaihdettava ja ladattava paristoakku. Materiaali nylon ja muovi. Johto kirkas. On/off-kytkin.

LED SOLCELLS-SERIE

En LED solcells-serie med vita och grå mini-rislampor. Varmvita LED-lampor, ej utbytbara. Utbytbart och laddningsbart batteri ingår. Tillverkad av nylon och plast. Genomskinlig sladd. Av-/på-knapp.

SOLAR LED SET

A ready-to-assemble solar set with white and grey balls. LED warm white, non-replaceable. Replaceable and rechargeable battery included. Material of nylon and plastic. Clear cord. On/off switch.



Nr 9477976



6 435200 233714



12

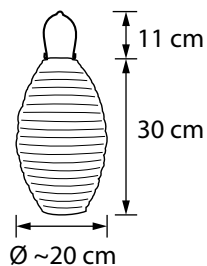

KENJI & ERIKO

SOLAR LED-LYHDYT

Ripusta ovaalilyhtyjä näyttäväksi ryhmäksi. LED lämmin valkoinen, ei vaihdettava. Mukana vaihdettava ja ladattava paristoakku. Materiaali nylon. On/off-kytkin.

SOLAR LED-LYKTOR

Hängbara ovala LED-lyktor med eller utan grafiskt tryck. Varmvit LED-lampa, ej utbytbar. Utbytbar och laddningsbart batteri ingår. Tillverkad av nylon. Av-/på-knapp.

SOLAR LED LANTERNS

Hang up oval lanterns to form an impressive group. LED warm white, non-replaceable. Replaceable and rechargeable battery included. Material of nylon. On/off switch.



Kenji

NR 9477973



6 435200 233677



Eriko

NR 9477975



6 435200 234865



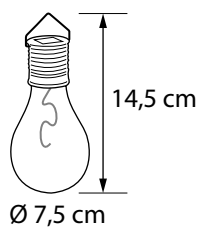

ROCKY

RIPUSTETTAVA SOLAR-LAMPPULYHTY

Lampunmallinen solar-lyhty, jonka sisällä on LED-sarja. Ripustusta vaikka useampi lamppu pihan piristykseksi! LED lämmin valkoinen, ei vaihdettava. Mukana ladattava nappiakku, ei vaihdettava. Materiaali muovi.

UPPHÄNGNINGSBAR SOLAR-LAMPLYKTA

En solar-lamplykta med LED-slinga inne i kupan. Häng upp flera lyktor för att skapa atmosfär eller för att navigera i trädgården vid mörker! LED varmvit, ej utbytbar. Laddningsbart knappbatteri ingår, ej utbytbar. Tillverkad av plast.

HANG-ON SOLAR LAMP-LANTERN

A solar lamp-lantern with a LED set inside. Hang up several lamps to brighten up your garden! LED warm white, non-replaceable. Rechargeable button battery included, non-replaceable. Made of plastic.



Nr 9478505



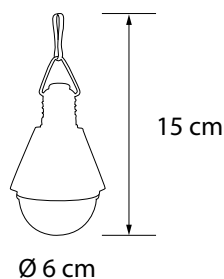

APOLLO

RIPUSTETTAVA SOLAR LED-LYHTY

Helposti ripustettava solar LED-koriste. LED lämmin valkoinen, ei vaihdettava. Mukana vaihdettava ja ladattava paristoakku. Materiaali muovi. On/Off-kytkin.

UPPHÄNGNINGSBAR SOLAR LED-LYKTA

Modern LED-solcellslampa som är smidig att fästa i ögla eller med medföljande låsbar hake. Varmvita LED, ej utbytbara. Bytbart och laddningsbart batteri ingår. Tillverkad av plast. Av-/på-knapp.

HANG-ON SOLAR LED LANTERN

A modern solar LED decoration, which is easy to hang up. LED warm white, non-replaceable. Replaceable and rechargeable battery included. Material of plastic. On/off switch.



Nr 9476251



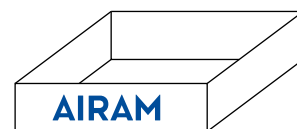
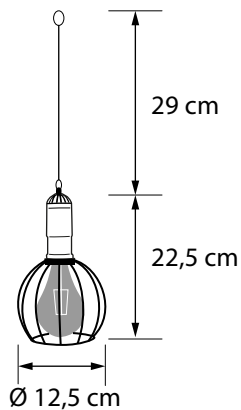

MALIK

RIPUSTETTAVA SOLAR-LAMPPULYHTY

Ripusta Industrial-henkinen lamppu terassin tai parvekkeen piristykseksi. LED lämmin keltainen, ei vaihdettava. Mukana vaihdettava ja ladattava paristoakku. Materiaali metalli ja muovi. On/off-kytkin.

UPPHÄNGNINGSBAR SOLAR-LAMPLYKTA

Modern LED-solcellslampa som är smidig att fästa i ögla eller med medföljande låsbar hake. Varmvita LED, ej utbytbara. Bytbart och laddningsbart batteri ingår. Tillverkad av plast. Av-/på-knapp.

HANG-ON SOLAR LAMP-LANTERN

Hang up the industrial style lamp to brighten up your terrace or balcony. LED warm yellow, non-replaceable. Replaceable and rechargeable battery included. Made of metal and plastic. On/off switch.



Nr 9478509



6 435200 246219



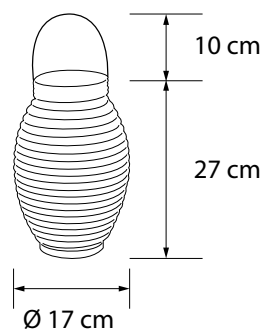

ALPI

SOLAR LED-LYHTY

Solar LED-lyhty, jonka sisällä kiinteä solar led-kynttilä. LED lämmin keltainen, ei vaihdettava. Mukana vaihdettava ja ladattava paristoakku. Materiaali muovi. On/off-kytkin.

SOLAR LED-LYKTA

Dekorativ solcellslykta med fast LED-blockljus. Varmvit LED-lampa, ej utbytbar. Auto on/off. Utbytbar och laddningsbart batteri ingår. Tillverkad av plast. Av-/på-knapp.

SOLAR LED LANTERN

A lantern with a fixed solar LED candle on the inside. LED warm yellow, non-replaceable. Replaceable and rechargeable battery included. Material of plastic. On/off switch.



Nr 9477972





DANI

RIPUSTETTAVA SOLAR-LASILYHTY

Kaunis pieni solar lasilyhty, joka on erityisen näyttävä useamman lyhdyn ryhmässä. LED lämmin valkoinen, ei vaihdettava. Mukana vaihdettava ja ladattava paristoakku. Poista paristoakku suojaava liuska ennen käyttöä. Materiaali metalli ja lasi. On/off-kytkin.

UPPHÄNGNINGSBAR SOLAR-GLASLYKTA

Vacker liten LED-solcellslykta som ger ett behagligt sken. Hängs med fördel i grupper om fler. Varmvit LED, ej utbytbar. Utbytbar och laddningsbart batteri ingår. Avlägsna materialet som skyddar batteriet innan användning. Tillverkad av glas och metall. Av-/på-knapp.

HANG-ON SOLAR GLASS LANTERN

Beautiful small solar glass lanterns that look especially impressive when grouped together. LED warm white, non-replaceable. Replaceable and rechargeable battery included. Remove the slip protecting the battery. Material of glass and metal. On/off switch.

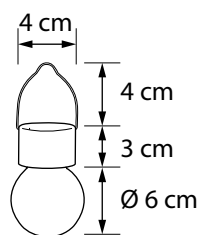

Nr 9477810





DANI

SOLAR-LASIPOLLARI

Kaunis maahan upotettava solar lasilyhty. Kenno-osa lasipallon sisällä, on/off-kytkin. Led 1 kpl lämmin valkoinen, ei vaihdettava. Mukana vaihdettava ja ladattava paristoakku. Materiaali metalli ja lasi. On/off-kytkin.

SOLAR-GLASPELLARE

Vacker LED-solcellspollare med markspjut. Solcellen är monterad inuti en skärm av glas med en på/av-knapp. Varmvit LED, ej utbytbar. Bytbar och laddningsbart batteri ingår. Tillverkad av glas och metall. Av-/på-knapp.

SOLAR GLASS BOLLARD

A beautiful solar glass lantern with integrated ground spike. The solar panel and the on/off switch are inside a glass sphere. LED warm white, non-replaceable. Replaceable and rechargeable battery included. Material of glass and metal. On/off switch.

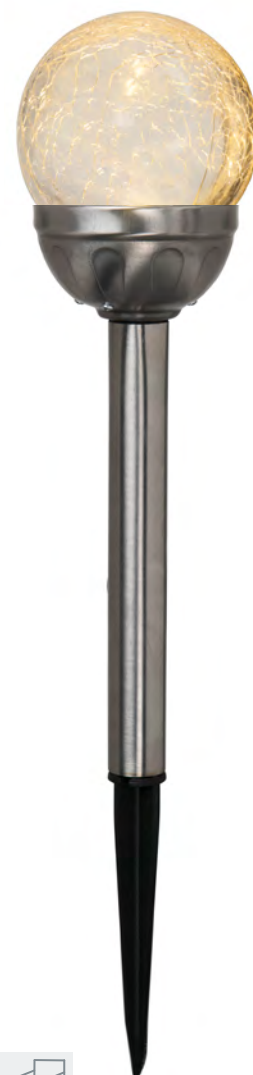
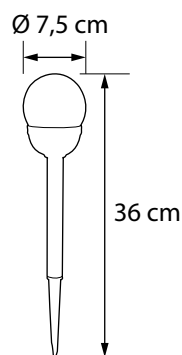

Nr 9477811



6 435 200 2177 69



12

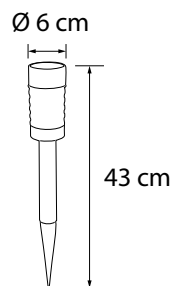

NEMO

SOLAR-POLLARI

Klassinen solar-lyhty ohjaamaan kulkua pihapolulla tai reunustamaan kukkapenkkiä. LED lämmin valkoinen, ei vaihdettava. Mukana vaihdettava ja ladattava paristoakku. Materiaali metalli ja lasi. On/off-kytkin lasiosan sisällä.

SOLAR-POLLARE

En klassisk LED-Solcellspollare som kan lysa upp gången eller dekorativt i en plantering. Varmvit LED, ej utbytbar. Bytbart och laddningsbart batteri ingår. Tillverkad av metall och glas. Av-/på-knapp inuti glasdelen.

SOLAR BOLLARD

A classic solar lantern to light the garden path or line a flower bed. LED warm white, non-replaceable. Replaceable and rechargeable battery included. Material of metal and glass. On/off switch inside the glass part.



Nr 9477971



6 435200 234841



12

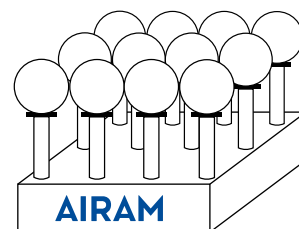
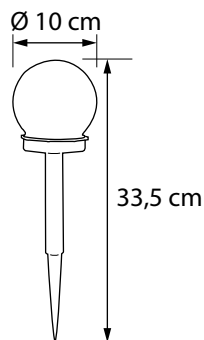

PALMER

SOLAR-POLLARI

Solar-lyhdyssä on klassinen pyöreä muoto. Valo kajastaa kauniisti valkoisen kuvun sisältä. Maapiikki on jalkaosan sisällä. Led valkoinen, ei vaihdettava. Mukana ladattava nappiakku, ei vaihdettava. On/off-kytkin.

SOLAR-POLLARE

Solar-lyktan har en klassisk rund form. Den vita kupan ger ett vackert ljus. Markspjutet finns i fotdelen. LED vit, ej utbytbar. Laddningsbart knappbatteri ingår, ej utbytbar. Av-/på-knapp.

SOLAR BOLLARD

The solar lantern has a classic round shape. The white globe gives a beautiful light. The ground spike is in the foot part. LED white, non-replaceable. Rechargeable button battery included, non-replaceable. On/off switch.



Nr 9478504



6 435200 245922





LUCY

SOLAR PYLVÄS

Kolmesta varsiosta koostuvaa solar-pylvästä voi säätää kahteen eri mittaan käyttämällä joko kaikkia kolmea tai vain kahta varsiosta. Helppo asentaa ja siirtää. LED kirkas, ei vaihdettava. Mukana vaihdettava ja laddattava paristoakku. Materiaali teräs, mattalasi ja muovi. On/off-kytkin.

SOLCELLARMATUR

Solcellsarmatur med justerbar höjd i tre nivåer. Använd 2 eller 3 stolpdelar för den höjd som passar dig. Enkel att montera och flytta runt. Klar LED, ej utbyttbar. Byttbart och laddningsbart batteri ingår. Tillverkad av stål, matt glas och plast. Av-/på-knapp.

A SOLAR COLUMN

A solar column consisting of three shaft sections that can be adjusted to two different lengths, using either all three or just two of the shaft parts. Easy to install and move around. LED clear, non-replaceable. Replaceable and rechargeable battery included. Material of steel, matte glass and plastic. On/off switch.

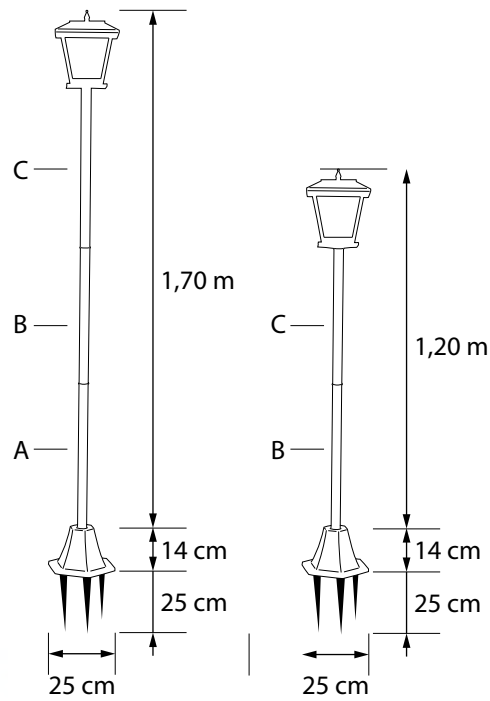

Nr 9477803





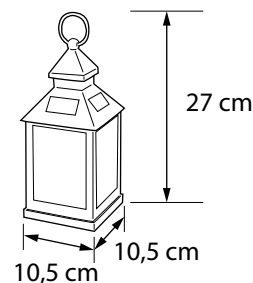

TIOGA

SOLAR-LIEKKILYHTY

Solar-lyhdyssä on näyttävä liekkiefekti: valo lepattaa aidon liekin tavoin, mutta turvallisesti. Aurinkokenno lataa lyhtyyn virtaa päivisin on-asennossa. Hämäräkytkin sytyttää valon automaattisesti illalla. LED keltainen, ei vaihdettava. Mukana vaihdettava ja ladattava paristoakku. Materiaali muovi ja lasi. On/off-kytkin.

SOLAR-LYKTA MED LEVANDE LÅGA

Solar-lyktan med levande låga, ljuset fladdrar som från ett riktigt ljus, men utan eld. När solcellen är på laddar den ström i lyktan under dagen. Skymningsreläet tändes ljuset automatiskt på vid skymning. LED varmvit, ej utbytbar. Utbytbar och laddningsbart batteri ingår. Tillverkad av plast och glas. Av-/på-knapp.

FLICKERING SOLAR LANTERN

The solar lantern has an impressive flickering effect: the light flickers like a real flame, but safely. When the solar cell is on, it recharges the lantern in the daytime. The light-sensitive switch automatically turns on the light in the evening. LED yellow, non-replaceable. Replaceable and rechargeable battery included. Made of plastic and glass. On/off switch.



Nr 9478503



6 435200 245908



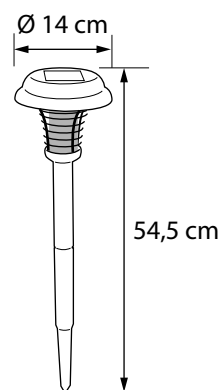

LESTER

SOLAR-LIEKKIPOLLARI

Solar-pollarissa on näyttävä liekkiefekti: valo lepattaa aidon liekin tavoin, mutta turvallisesti. Luo tunnelmaa pihapolulle tai puutarhaan. Aurinkokenno lataa lyhtyyn virtaa päivisin on-asennossa. Hämäräkytkin sytyttää valon automaattisesti illalla. LED keltainen, ei vaihdettava. Mukana vaihdettava ja ladattava paristoakku. Materiaali muovi. On/off-kytkin.

SOLAR-POLLARE MED LEVANDE LÅGA

Solar-lyktan med levande låga, ljuset fladdrar som från ett riktigt ljus, men utan eld. Skapar stämning vid altanen eller i trädgården. När solcellen är på laddar den ström i lyktan under dagen. Skymningsreläet tänds ljuset automatiskt vid skymning. LED varmvit, ej utbytbar. Utbytbar och laddningsbart batteri ingår. Tillverkad av plast. Av-/på-knapp.

FLICKERING SOLAR BOLLARD

The solar bollard has an impressive flickering effect: the light flickers like a real flame, but safely. Creates an atmosphere by the path or in the garden. In the daytime when the solar cell is on, it recharges the lantern. The light-sensitive switch automatically turns on the light in the evening. LED yellow, non-replaceable. Replaceable and rechargeable battery included. Made of plastic. On/off switch.



Nr 9478502



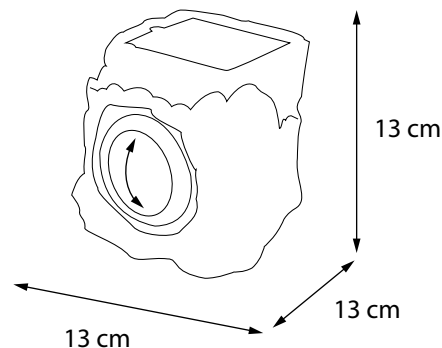

KANTO

SOLAR-KORISTE

Aseta kanto ulos sille sopivaan paikkaan. On-asennossa aurinkokenno lataa päivisin virtaa, hämärän laskeuduttua LED-valo syttyy automaattisesti. On/off-kytkimestä voit valita joko väriävaihtavan tai lämpimän valkoisen LED-sävyä. Linssi-osaa voi säätää ylös ja alas, joten voit suunnata valon haluamallasi tavalla. LED lämmin valkoinen tai väriävaihtava, ei vaihdettava. Mukana vaihdettava ja ladattava paristoakku. Materiaali muovi. On/off-kytkin.

SOLAR-DEKORATION

Placera stubben utomhus på en lämplig plats. När solcellen är på laddar den ström under dagen och när det skymmer tänds LED-ljuset automatiskt. Med av-/på-knappen kan du välja antingen en färgväxlande eller en varmvit LED. Linsen kan ställas in upp och ner så ljuset kan riktas. LED varmvit eller färgväxlande, ej utbytbar. Utbytbar och laddningsbart batteri ingår. Tillverkad av plast. Av-/på-knapp.

SOLAR ORNAMENT

Place the stump outdoors in a suitable place. When the solar cell is on, it recharges in the daytime, and when it gets dark, the LED light goes on automatically. With the on/off switch, you can choose either a colour-changing or a warm white LED. The lens part can be adjusted up or down, so you can direct the light the way you want it. LED warm white or colour-changing, non-replaceable. Replaceable and rechargeable battery included. Made of plastic. On/off switch.



Nr 9478506



6 435200 245960



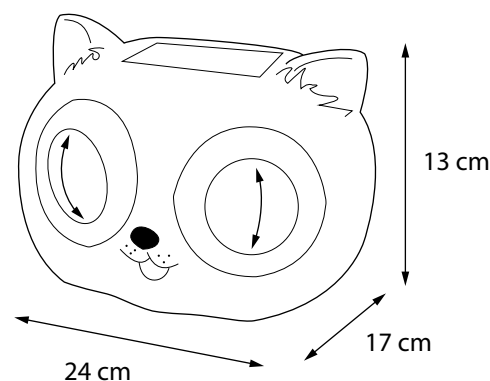

GRIN

SOLAR-KORISTE

Ilmeikkään kissan pään voi asetella kurkkimaan vaikka pensaas juurelta. On-asennossa aurinkokenno latautuu, hämärän tultua kissan silmiin syttyy automaattisesti valo. On/off-kytkimestä voit valita joko väri-vaihtavan tai lämpimän valkoisen LED-sävyä. Kissan silmiä voi liikuttaa erikseen ylös ja alas ja siten suunnata valoa. LED 2 kpl: 1 kpl/silmä, lämmin valkoinen tai väriävaihtava, ei vaihdettava. Mukana vaihdettava ja ladattava paristoakku. Materiaali muovi. On/off-kytkin.

SOLAR-DEKORATION

Placera Grin på lämpligt ställe och använd fantasin för att skoja med vänner! När solcellen är på laddar den ström på dagen och när det blir skymning tänds ljuset i ögonen automatiskt. Med av-/på-knappen kan du välja antingen en färgväxlande eller varmvit LED. Kattens ögon är justerbara så ljuset kan riktas. LED 2 st.: 1 st./öga, varmvita eller färgväxlande, ej utbytbara. Utbytbara och laddningsbara batteri ingår. Tillverkad av plast. Av-/på-knapp.

SOLAR ORNAMENT

The cat's head can be adjusted to have its expressive face peep e.g. from a bush or shrub. When the solar cell is on, it recharges, and when it gets dark, the light in the cat's eyes goes on automatically. With the on/off switch, you can choose either a colour-changing or a warm white LED. You can direct the light by turning the cat's eyes up or down. LED 2 pcs: 1 pc/eye, warm white or colour-changing, non-replaceable. Replaceable and rechargeable battery included. Made of plastic. On/off switch.



Nr 9478507



6 435200 245984



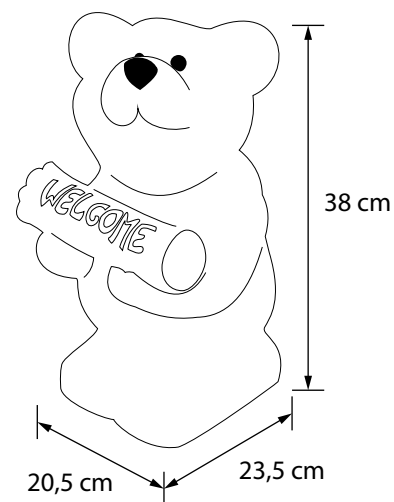

KARHU

SOLAR KORISTE

Hauska karhu toivottaa vieraat tervetulleiksi. Welcome -teksti kajastaa pehmeästi valoa solar-energian voimalla. LED kirkas, ei vaihdettava. Mukana vaihdettava ja ladattava paristoakku. Materiaali lasikuitu ja muovi. On/off-kytkin.

SOLAR-BJÖRN

En skojig björn som hälsar gästerna välkomna. Ordet Welcome lyser sobert med sollceller och batteri. Klara LED-lampor, ej utbytbara. Utbytbart och laddningsbart batteri ingår. Tillverkad av glasfiber och plast. Av-/på-knapp.

SOLAR BEAR

A funny bear to welcome your guests. The word Welcome shines softly with solar energy. LED clear, non-replaceable. Replaceable and rechargeable battery included. Material of fibreglass and plastic. On/off switch.



Nr 9477982



6 435200 233653



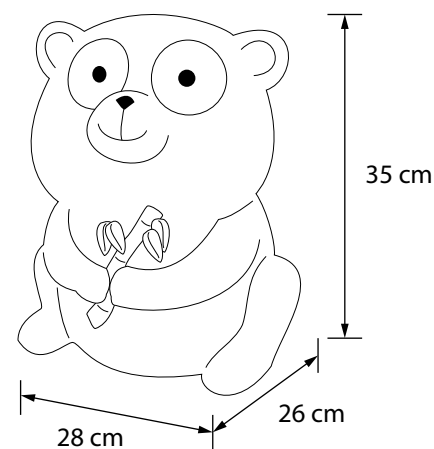

PANDA

SOLAR-KORISTE

Suloinen solar panda ilahduttaa ja syö väsymättä bambua vehreällä pihamaallasi. Led 2 kpl: 1 kpl/silmä, kirkas, ei vaihdettava. Mukana vaihdettava ja ladattava paristoakku. Materiaali lasikuitu ja muovi. On/off-kytkin.

SOLAR-PANDA

En söt panda som gör dig glad var den än placeras i din trädgård eller bostad. 2 st klara LED-lampor (1 st/öga), ej utbytbara. Utbytbart och laddningsbart batteri ingår. Tillverkad av glasfiber och plast. Av-/på-knapp.

SOLAR PANDA

A cute little solar panda cheering you up and always eating bamboo in your garden. LED 2 pcs: 1 pc/eye, clear, non-replaceable. Replaceable and rechargeable battery included. Material of fibreglass and plastic. On/off switch.



Nr 9477981



6 435200 233325



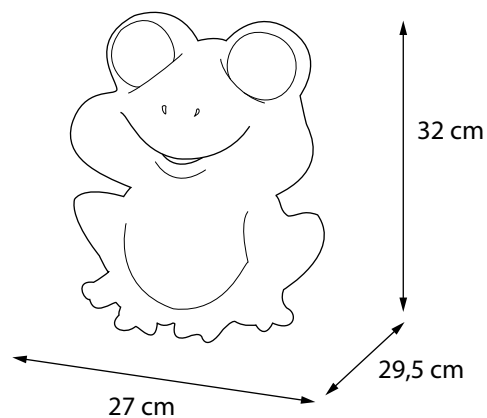

SAMMAKKO

ISO SOLAR-KORISTE

Hauska, iso solar LED-sammakko ilahduttaa puutarhassa. LED 2 kpl: 1 kpl/silmä, valkoinen, ei vaihdettava. Mukana vaihdettava ja ladattava paristoakku. Materiaali lasikuitu ja muovi. On/off-kytkin.

STOR DEKORATIONSGRODA MED SOLCELLER

Stor dekorationsgröda med solceller för att liva upp i trädgården. 2 st vita LED-lampor (1 st/öga), ej utbytbara. Utbytbar och laddningsbart batteri ingår. Tillverkad av glasfiber och plast. Av-/på-knapp.

LARGE SOLAR LED FROG

A fun, large solar LED frog. A delight in the garden. LED 2 pcs: 1 pc/eye, white, non-replaceable. Replaceable and rechargeable battery included. Material of fibreglass and plastic. On/off switch.



Nr 9477802



6 435200 217240



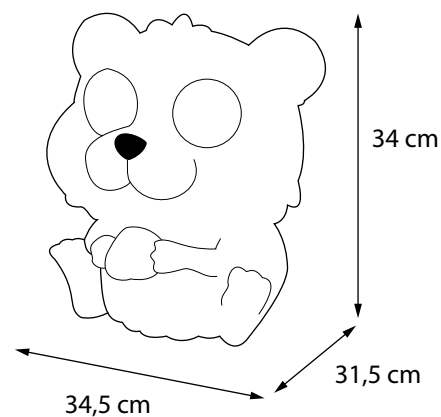

ORAVA

ISO SOLAR-KORISTE

Iso solar LED-orava tuo iloa pihalle tai terassille. LED 2 kpl: 1 kpl/silmä, valkoinen, ei vaihdettava led. Mukana vaihdettava ja ladattava paristoakku. Materiaali lasikuitu ja muovi. On/off-kytkin.

STOR DEKORATIV EKORRE MED SOLCELLER

Stor dekorativ ekorre med solceller och lysande ögon för att utsmycka gården eller terrassen. 2 st vita LED-lampor (1 st/öga), ej utbytbara. Utbytbart och laddningsbart batteri ingår. Tillverkad av glasfiber och plast. Av-/på-knapp.

LARGE SOLAR LED SQUIRREL

A large solar LED squirrel that brings delight to the yard or terrace. LED 2 pcs: 1 pc/eye, white, non-replaceable. Replaceable and rechargeable battery included. Material of fibreglass and plastic. On/off switch.



Nr 9477799





PÖLLÖ

ISO SOLAR-KORISTE

Upea, suuri solar LED-pöllö pihan piristykseksi. LED 2 kpl: 1 kpl/silmä, lämmin valkoinen, ei vaihdettava. Mukana vaihdettava ja ladattava paristoakku. Materiaali muovi. On/off-kytkin.

STOR DEKORATIONSUGGLA MED SOLCELLER

Praktfull Uggla med LED-ögon och solceller för gårdsdekoration. 2 st varmvita LED-lampor (1 st/öga), ej utbytbara. Utbytbar och laddningsbart batteri ingår. Tillverkad av plast. Av-/på-knapp.

LARGE SOLAR LED OWL

A gorgeous, large solar LED owl to spice up the yard. LED 2 pcs: 1 pc/eye, warm white, non-replaceable. Replaceable and rechargeable battery included. Material of plastic. On/off switch.

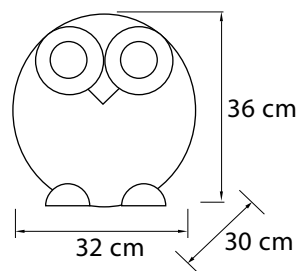

Nr 9477781



6 435200 194350





PARISTOAKUT

Solar led-tuotteiden ladattavat nikkelimetallihybridiparistoakut voi vaihtaa vastaavaan uuteen. Akkuja voidaan käyttää myös muissa ladattavissa tuotteissa, joissa on vastaavat tiedot ja arvot.

UPPLADNINGSBARA BATTERIER

Uppladdningsbara och utbytbara LED-nickel-metallhydrid-solarbatterier. Batterierna kan också användas med uppladdningsbara produkter med motsvarande specifikationer och värden.

RECHARGEABLE BATTERIES

The rechargeable nickel-metal hydride batteries of the solar LED products can be replaced with new ones. The batteries can also be used in other appropriate rechargeable products.



NI-MH 2/3 AA 100 mAh 1,2V
Nr 9476205



NI-MH AA 300 mAh 1,2V
Nr 9476203



NI-MH AA 600 mAh 1,2V
Nr 9476207



NI-MH AA 700 mAh
Nr 9476208



NI-MH AAA 300 mAh 1,2V
Nr 9476204



NI-MH AAA 600 mAh 1,2V
Nr 9476206



LI-ION AA 600 mAh 3,2V
Nr 9476209







NEW



LED
10



3x
LR44

10 000
H

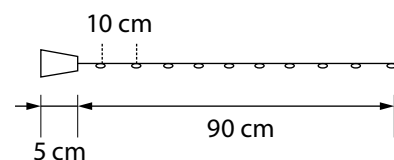

ELLI

PULLOVALO

Luo tyhjästä pulloista tai purnukoista kauniita valokoristeita. Paristot on piilotettu "korkin" sisälle. LED lämmin valkoinen tai värimix, ei vaihdettava. Sisältää paristot. Materiaali metalli, korkkiosa muovia. On/off-kytkin.

FLASKLJUS

Skapa kreativa ljusdekorationer av tomma flaskor eller glasburkar. Batterierna är gömda i "korken". LED varmvit eller färgmix, ej utbytbar. Batterier medföljer. Tillverkad av metall, korkdelen av plast. Av-/påknapp.

BOTTLE LIGHT

Create beautiful light ornaments of empty bottles or jars. The batteries lie hidden in the "cork". LED warm white or colour mix, non-replaceable. Batteries included. Made of metal, the cork part of plastic. On/off switch.

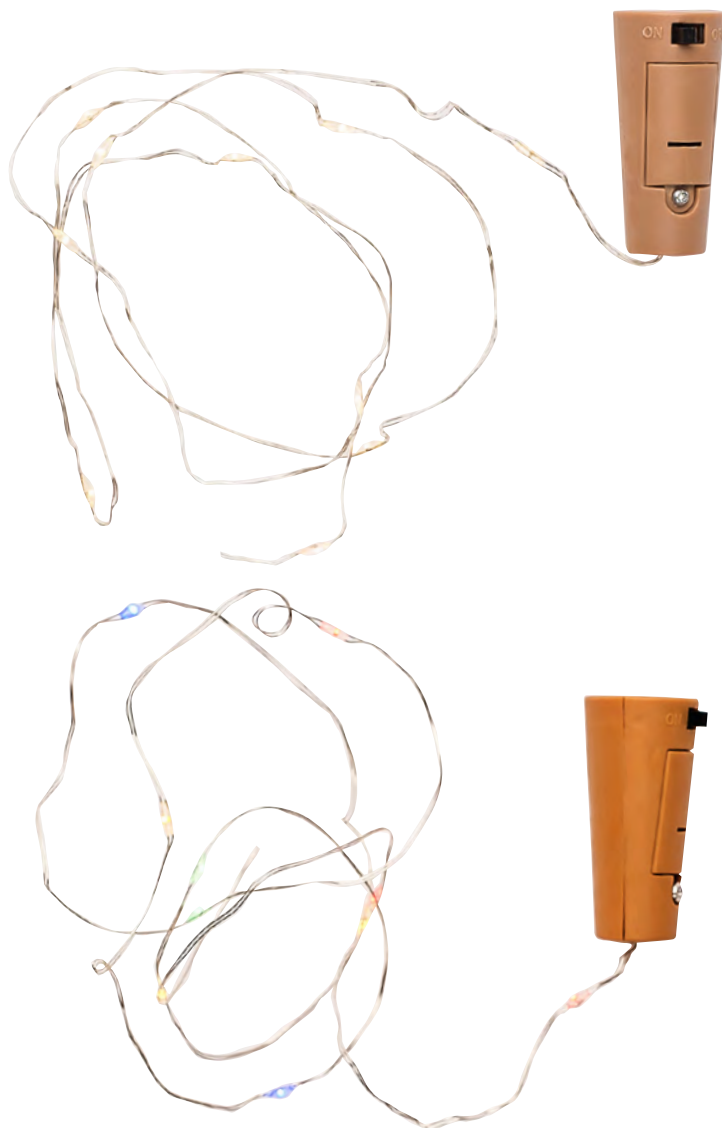

Nr 9478510





POINT

USB-VALONAUHA

Hauska, USB-liitännän kautta toimiva LED-nauha koristeluun ja tunnelmaa tuomaan. Tuote on tarkoitettu vain koristekäyttöön. Kaksi eri pituutta. LED lämmin valkoinen, ei vaihdettava. Materiaali metalli ja muovi.

USB-LJUSBAND

Ett roligt LED-band att dekorera och skapa stämning med. Fungerar med USB så prova koppla med datorn eller TV'n. Får användas endast för dekoration. Två längder. LED varmvit, ej utbytbar. Tillverkad av metall och plast.

USB LIGHT RIBBON

A nice USB powered LED ribbon for ornamentation and creating atmosphere. The product is intended for ornamentation only. Two different lengths. LED warm white, non-replaceable. Made of metal and plastic.

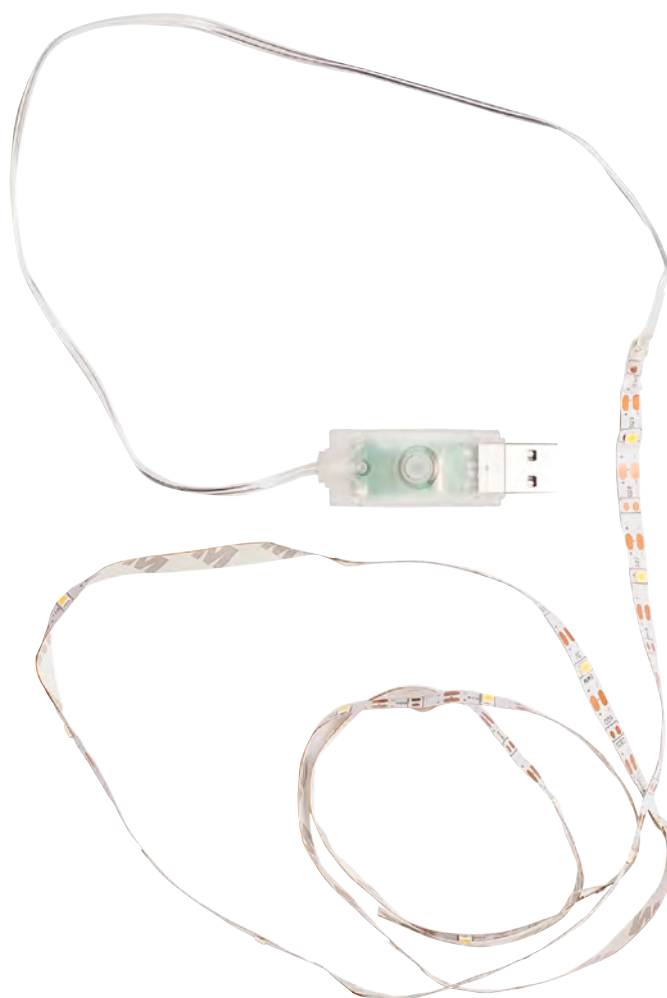
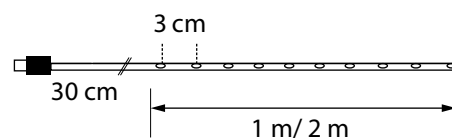

LED
30

1 m
NR 9478519



6 4 3 5 2 0 0 2 4 6 9 0 5



24

LED
60

2 m
NR 9478520



6 4 3 5 2 0 0 2 4 6 9 2 9



24



NEW



LED
10



2x
CR2032



10 000
H

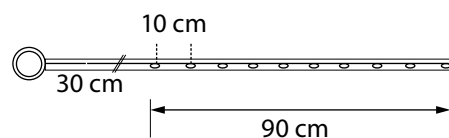

MEA IP44

VALOLANKA

Ulkokäyttöön soveltuva valolanka, jonka paristokotelo on suojattu vesiroiskeilta. Asettele esim. parvekkeella koristelyhtyen sisälle. LED lämmin valkoinen, ei vaihdettava. Sisältää paristot ja ajastimen. Materiaali metalli ja muovi. On/off- ja ajastinkytkin.

LJUSTRÅD

En ljustråd som lämpar sig för utomhusbruk. Batterifodralet är skyddat mot vattenstänk. Kan t.ex. placeras i dekorationslykter på balkongen eller i blomkrukor. LED varmvit, ej utbytbar. Innehåller batterier och en timer. Tillverkad av metall och plast. Av-/på- och timerknapp.

LIGHT STRING

A light string suitable for outdoor use. The battery casing is protected against splashes. Can be placed e.g. in ornamental lanterns in the balcony. LED warm white, non-replaceable. Batteries and timer included. Made of metal and plastic. On/off and timer switch.



Nr 9478512



6 435 200 246 271



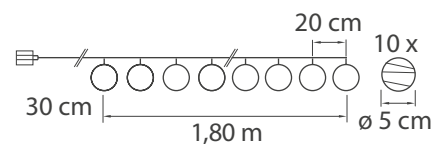

CANDY IP44

PALLOSARJA

Pallosarja, jossa on kaunis pintakuviointi. Paristokotelo on suojattu vesiroiskeilta ja soveltuu siksi myös ulkokäyttöön. Palloissa valittavissa kaksi eri värisävyä. LED lämmin valkoinen, ei vaihdettava. Sisältää paristot ja ajastimen. Materiaali muovi, johto kirkas. On/off- ja ajastinkytkin.

BOLLSERIE

En bollserie med vacker ornamentering. Batterifodralet är skyddat mot vattenstänk och lämpar sig därför även för utomhusbruk. Bollarna finns i två olika färgtoner. LED varmvit, ej utbytbar. Innehåller batterier och en timer. Tillverkad av plast, sladden är klar. Av-/på- och timerknapp.

BALL SET

A set of beautifully ornamented balls. As the battery casing is protected against splashes, it is suitable for outdoor use. The balls come in two different shades. LED warm white, non-replaceable. Batteries and timer included. Made of plastic, the cord is colourless. On/off and timer switch.



Valkoinen/ Vit/ White

Nr 9478513



6 435200 246295



Pastel-mix

Nr 9478514



6 435200 246318





NEW



LED



4 x AA



10 000 H

PARIS IP44

KORISTEVALO

Kaunis koristevalaisin, jossa on ulkokäyttöön soveltuva, vesiroiskeilta suojattu paristokotelo. Luo tunnelmaa esim. parvekkeelle tai kuistille. Ei vaadi sähköjohtoja ja on helppo ripustaa. Mallisuoja lampu. LED lämmin valkoinen, ei vaihdettava. Sisältää paristot ja ajastimen. Materiaali metalli ja muovi. On/off- ja ajastinkytkin.

DEKORATIONSGLAMP

En vacker dekorationslampa med ett batterifodral som lämpar sig för utomhusbruk och är skyddat mot vattenstänk. Skapar stämning t.ex. på balkongen eller verandan. Behöver inga sladdar. Lätt att hänga upp. En mönsterskyddad lampa. LED varmvit, ej utbytbar. Innehåller batterier och en timer. Tillverkad av metall och plast. Av-/på- och timerknapp.

ORNAMENTAL LAMP

A beautiful ornamental lamp with a battery casing suitable for outdoor use and protected against splashes. Creates atmosphere e.g. in the balcony or on the porch. Needs no cords. Easy to hang up. A protected design. LED warm white, non-replaceable. Batteries and timer included. Made of metal and plastic. On/off and timer switch.



Nr 9478015



6 435200 237019





NEW



IP44

LED
10



10 000
H

30V 3W
IP44

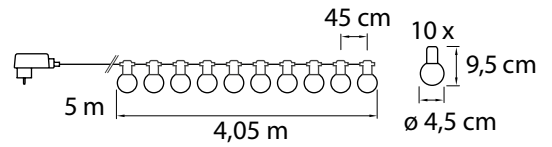

NASHUA IP44

LAMPPUSARJA

Sisä- ja ulkokäyttöön soveltuva Nashua korvaa perinteisen Bile-sarjan. Lamppujen sisältä näkyvä filamentti luo kokonaisuudesta kevyen ja raikkaan. Monikäyttöisellä lamppusarjalla piristät sekä arkea että juhlaa. Lamppukuvuissa kaksi eri sävyvaihtoehtoa. LED lämmin valkoinen, ei vaihdettava. Johto tumma.

LJUSSLINGA

Nashua som lämpar sig både för inom- och utomhusbruk ersätter Airam's traditionella Bile-serien. Synliga filamentstavar ger ett stämningsfullt ljus. En mångsidigt och användbar lampserie för både vardag och fest. Kuporna finns i två olika färgtoner. LED varmvit, ej utbyttbar. Sladden är mörk.

LAMP SET

Suitable for in- and outdoor use, the Nashua set replaces the traditional Bile set. The filament visible in the lamps makes the set light and fresh. A versatile lamp set to brighten up any occasion. The globes come in two different shades. LED warm white, non-replaceable. The cord is dark.



Kirkas/ Klar/ Clear

Nr 9478517



6 4 3 5 2 0 0 2 4 6 8 5 1



6



Värimix/ Färgmix/ Colour mix

Nr 9478518



6 4 3 5 2 0 0 2 4 6 8 7 5



6



NEW



IP44

LED
10



WARM
WHITE



4V 2W
IP44

10 000
H

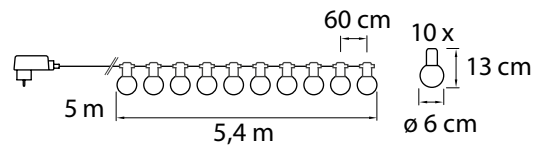

NORTE IP44

LAMPPUSARJA

Norte lamppusarjalla luot näyttäviä kokonaisuuksia sekä sisälle että ulos. Litteä johto luo valosarjaan oman ilmeensä ja on myös ripustettaessa tukeva ja helppo asetella. LED lämmin valkoinen, ei vaihdettava. Johto musta.

LJUSSLINGA

Med slingan Norte skapar du kreativa upphängningar både inom och utomhus. Den platta sladden ger slingan en egen karaktär och är även stadig vid upphängning och lätt att placera. LED varmvit, ej utbytbar. Sladden är svart.

LAMP SET

With the Norte lamp set, you can create impressive ornamentations both in- and outdoors. The flat cord gives the lamp set a special look, it is steady while hanging and easy to arrange. LED warm white, non-replaceable. The cord is black.



Nr 9478515



6 435 200 244 871





NEW



IP44

LED
10



10 000
H

30V 3W
IP44

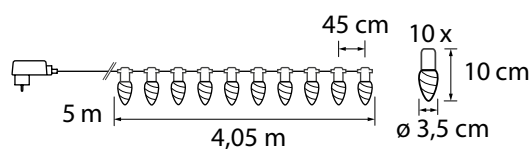

NEPTUS IP44

KYNTTILÄLAMPPUSARJA

Neptus -lamppusarjan kirkkaissa kynttilälampuissa on kaunis kierrekuvio. LED-sarja soveltuu sekä sisä- että ulkokäyttöön ja sillä voi koristella vaikka pihan koristepuun tai luoda tunnelmaa terassille. LED lämmin valkoinen, ei vaihdettava. Johto tumma.

KRONLJUS-SLINGA

De klara kronljuslamporna i ljusslingan Neptus har ett vackert spiralmönster. LED-serien lämpar sig både för inom- och utomhusbruk, och kan hängas både i trädgården och på terrassen. LED varmvit, ej utbytbar. Sladden är mörk.

CANDLE LAMP SET

The clear candle lamps in the Neptus lamp set have a beautiful spiral pattern. The LED set is ideal for both in- and outdoor use. It can be used for decorating an ornamental tree or creating an atmosphere on the terrace. LED warm white, non-replaceable. The cord is dark.



Nr 9478516



6 435200 244895



6



4 SEASONS



4
SEASONS

4Seasons -valikoima saatavissa varastosta ympäri vuoden.
4Seasonssortimentet finns i lager året om.
4Seasons range is available in stock all year.



4 SEASONS



LED 20



3x AA



10 000 H

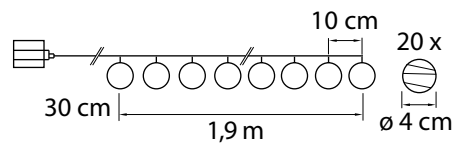

MINNI 20

LED-LANKAPALLOT

Kattauksiin ja koristeluun sopivat, ohuella puuvillalangalla päällystetyt pallot. Herkulliset värisävyt. Matta tai kiiltävä lanka. Led lämmin valkoinen, ei vaihdettava, kytketty 10 ledin sarjaan. Sisältää paristot. Johto kirkas. On/off-kytkin.

LED-TRÅDBOLLAR

Bollar beklädda med tunt bomullssnöre, perfekt för dukning och som dekoration. Läckra nyanser. Matt eller glansigt snöre. Varmvita LED-lampor, ej utbytbara, kopplade i serie om tio lampor. Batterier medföljer. Genomsiktig sladd. Av/på-knapp.

LED COTTON THREAD BALLS

Spheres covered with thin cotton thread for decoration and table-setting. Delicious tones! Matte or gloss thread. LED warm white, non-replaceable, connected with 10 LEDs in a series. Batteries included. Clear cord. On/off switch.

Champagne
Kiiltävä/ Glansig/ Glossy

Nr 9477912



6 435 200 218 087



Lemon
Matta/ matt/ matte

Nr 9477925



6 435 200 220 349



Beige
Matta/ matt/ matte

Nr 9476048



6 435 200 207 098



Coffee
Matta/ matt/ matte

Nr 9477927



6 435 200 220 387



Si-va/ Blå-vitt/ blue-wht
Matta/ matt/ matte

Nr 9477991



6 435 200 235 640





4 SEASONS



IP20

LED 10



WARM WHITE



10 000 H

31V 3,6VA

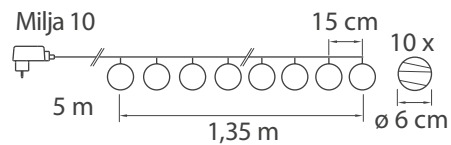

MILJA 10

LED-LANKAPALLOT

Sisustukseen sopivat, ohuella puuvillalangalla päällystetyt pallot. Herkulliset värisävyt. Matta tai kiiltävä lanka. Led lämmin valkoinen, ei vaihdettava, kytketty 10 ledin sarjaan. Johto kirkas.

LED-TRÅDBOLLAR

Bollar beklädda med tunt bomullssnöre, perfekt för heminredning. Läckra nyanser. Matt eller glansigt snöre. Varmvita LED-lampor, ej utbytbara, kopplade i serie om tio lampor. Genomskinlig sladd.

LED COTTON THREAD BALLS

Spheres covered with thin cotton thread for decoration. Delicious tones! Matte or gloss thread. LED warm white, non-replaceable, connected with 10 LEDs in a series. Clear cord.

Champagne
Kiiltävä/ Glansig/ Glossy

Nr 9477921



6 435 200 220240



Lemon
Matta/ matt/ matte

Nr 9477922



6 435 200 220264



Beige
Matta/ matt/ matte

Nr 9476052



6 435 200 207173



Coffee
Matta/ matt/ matte

Nr 9477924



6 435 200 220400



Si-va/ Blå-vitt/ blue-wht
Matta/ matt/ matte

Nr 9477889



6 435 200 218582





4 SEASONS



IP20

LED 20



WARM WHITE



31V 3,6VA

10 000 H

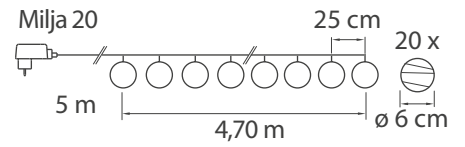

MILJA 20

LED-LANKAPALLOT

Sisustukseen sopivat pitkät lankapallosarjat, joissa ohuella puuvillalangalla päällystetyt pallot. Kaksi eri sävyä. Led lämmin valkoinen, ei vaihdettava, kytketty 10 ledin sarjaan. Johto kirkas.

LED-TRÅDBOLLAR

Långa ljusslingor med bollar beklädda med ett tunt bomullssnöre, perfekt för heminredning. Tillgängliga i två nyanser. Varmvita LED-lampor, ej utbytbara, kopplade i serie om tio lampor. Genomskinlig sladd.

LED COTTON THREAD BALLS

Sets of spheres covered with thin cotton thread on longer wires for decoration. Two different tones. LED warm white, non-replaceable, connected with 10 LEDs in a series. Clear cord.



Valkoinen/ Vit/ White

Nr 9477027



6 435200 196200



Värimix/ Färgmix/ Colour mix

Nr 9477018



6 435200 195982





4 SEASONS



IP20

LED 48



10 000 H

31V 3,6W

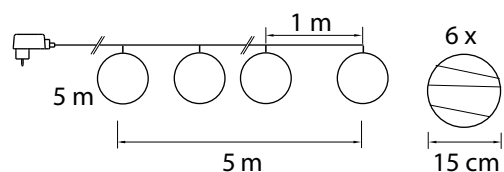

MILJA 6, Ø 15 CM

LED-LANKAPALLOT

Upeat ja isot, ohuella puuvillalangalla päällystetyt pallot (6 kpl, Ø 15 cm), sisustukseen sopivissa sävyissä. Pinoa tai aseta roikkumaan näyttäväksi kokonaisuudeksi. Led 48 kpl: 8 kpl/pallo, lämmin valkoinen, ei vaihdettava, kytketty 8 ledin sarjaan. Johto kirkas.

LED-TRÅDBOLLAR

Snygga, stora dekorationsbollar (6 st, Ø 15 cm) beklädda med tunn bomullstråd i färgtoner som passar olika inredningsstilar. Stapla eller häng upp till en vacker inredningsdetalj. 48 st. varmvita LED-lampor (8 st/boll), ej utbytbara, kopplade i serie om åtta lampor. Genomskinlig sladd.

LED COTTON THREAD BALLS

Beautiful, large decorative balls (6 pcs, Ø 15 cm) covered with thin cotton thread, in décor-friendly tones. Stack or hang up to create impressive and creative decorations. LED 48 pcs: 8 pcs/ball, warm white, non-replaceable, connected with 8 LEDs in a series. Clear cord.



Valkoinen/Vit/White, Ø 15 cm

Nr 9477956



Coffee, Ø 15 cm

Nr 9477957





4 SEASONS



IP20

LED 60



10 000 H

31V 3,6W

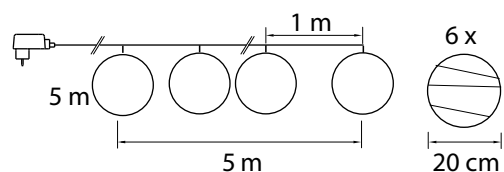

MILJA 6, Ø 20 CM

LED-LANKAPALLOT

Näyttävät ja suuret, ohuella puuvillalangalla päällystetyt pallo (6 kpl, Ø 20 cm), sisustukseen sopivissa sävyissä. Pinoa tai aseta roikkumaan näyttäväksi kokonaisuudeksi. Led 60 kpl: 10 kpl/pallo, lämmin valkoinen, ei vaihdettava, kytketty 10 ledin sarjaan. Johto kirkas.

LED-TRÅDBOLLAR

Imponerande, stora dekorationsbollar (6 st, Ø 20 cm) beklädda med tunn bomullstråd i färgtoner som passar olika inredningsstilar. Stapla eller häng upp till en vacker inredningsdetalj. 60 st. varmvita LED-lampor (10 st/boll), ej utbytbara, kopplade i serie om tio lampor. Genomskinlig sladd.

LED COTTON THREAD BALLS

Impressive, large decoration balls (6 pcs, Ø 20 cm) covered with thin cotton thread, in décor-friendly tones. Stack or hang up to create impressive and creative decorations. LED 60 pcs: 10 pcs/ball, warm white, non-replaceable, connected with 10 LEDs in a series. Clear cord.



Valkoinen/Vit/White, Ø 20 cm

Nr 9477954



Coffee, Ø 20 cm

Nr 9477955





4 SEASONS



LED 10



1xO CR2032

10 000 H

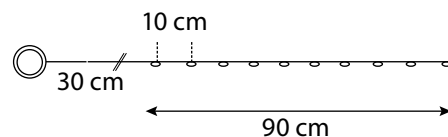

NAPPI

VALOLANKA

Kätevä valokoriste askarteluun, somisteisiin tai esim. kampauksiin! LED lämmin keltainen, ei vaihdettava, kytketty 10 LEDin sarjaan. Sisältää paristot. Materiaali ohut metallilanka, johon pienet LEDit on upotettu. On/off-kytkin.

LED-TRÅDSLINGA

Behändig ljusdekoration för pyssel, som prydnad eller t.ex. i frisyrrer! Varmgula LED-lampor, ej utbytbara, kopplade i serie om tio lampor. Batterier medföljer. Material: tunn metalltråd med små infällda LED-lampor. Av/på-knapp.

LED LIGHT WIRE

A handy light decoration for use in handicrafts, accessories or hairstyling, for example! LED warm yellow, non-replaceable, connected with 10 LEDs in a series. Batteries included. Made of thin metal wire into which the small LEDs are embedded. On/off switch.



Nr 9477552



6 435 200 208 163



24



4 SEASONS



LED 20

3x AA

6h TIMER

10 000 H

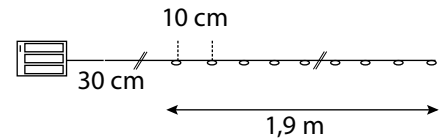

LED VALOLANKASARJAT

HOPEA JA KUPARI

Kaunis valolanka monipuoliseen koristeluun. LED lämmin valkoinen (hopea) tai keltainen (kupari), ei vaihdettava, rinnankytketty. Sisältää paristot. Materiaali ohut metallilanka, johon pienet LEDit on upotettu. On/off-kytkin.

LED-TRÅDSLINGA, SILVER OCH KOPPAR

Vacker dekorationsstring för många olika ändamål. Varmvita (silver) eller gula (koppar) LED-lampor, ej utbytbara, parallellkopplade. Batterier medföljer. Material: tunn metalltråd med små infällda LED-lampor. Av/på-knapp.

LED LIGHT WIRES, SILVER AND COPPER

A beautiful light wire for a wide variety of decorative purposes. LED warm white (silver) or yellow (copper), non-replaceable, parallel connection. Batteries included. Made of thin metal wire into which the small LEDs are embedded. On/off switch.

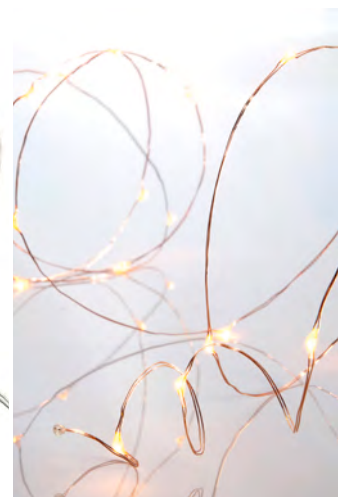

Hopea/ Silver
Nr 9477642



6 4 3 5 2 0 0 1 4 8 4 9 0



20



Kupari/ Kopper/ Copper
Nr 9476186



6 4 3 5 2 0 0 1 8 3 1 4 9



20



4 SEASONS



IP44

LED 96



10 000 H

4,5V 1,35W
IP44

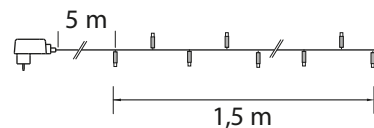

NIILI IP44

KIERRESARJA

Hopeanvärinen tai musta valosarja, joka taipuu helposti haluttuun muotoon. Kaunis esim. kuistilla pihalyhdyn sisällä. LED lämmin valkoinen, ei vaihdettava, rinnankytketty. Materiaali metalli. Johto kierretty hopea tai musta.

SPIRALSLINGA

LED-dekorationslinga i silver eller svart som enkelt kan formas. Vacker dekoration för t.ex. lyktan på verandan. Varmvita LED-lampor, ej utbytbara, parallellkopplade. Material: metall. Tvinnad sladd i silver eller svart.

SPIRAL CORD SET

A silver or black light set of lights that can be easily arranged into the desired shape. A beautiful decoration for the porch or inside a yard lantern, for example. LED warm white, non-replaceable, parallel connection. Made of metal. The wire is either black or twisted silver.



Nr 9477917



6 435200 220042



12
(6/6)





4 SEASONS



LED 15



3x AA



10 000 H

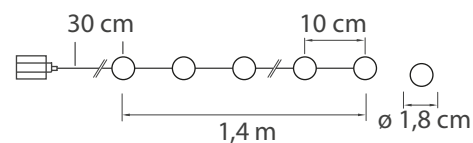

SAANA

KORISTESARJAT

Valikoimassa kolme erilaista kuviosarjaa: kukka, kide- ja helmipallo. LED lämmin valkoinen, ei vaihdettava, rinnankytketty. Sisältää paristot. Materiaali muovi. Johto hopea metallilanka. On/off-kytkin.

DEKORATIONSSLINGOR

I sortimentet finns tre olika mönster: blommor, kristall- och pärlbollar. Varmvita LED-lampor, ej utbytbara, parallellkopplade. Batterier medföljer. Material: plast. Sladd av silverfärgad metalltråd. Av/på-knapp

DECORATIVE LED LIGHT CHAINS

The selection contains three different patterns: flower, crystal and pearl. LED warm white, non-replaceable, parallel connection. Batteries included. Material: plastic, the cord consists of silver-coloured metal wire. On/off switch.



Saana
valikoima/ sektion/ selection

Nr 9477915



6 435200 220004



18
(6/6/6)



4 SEASONS



LED 15



3x AA



10 000 H

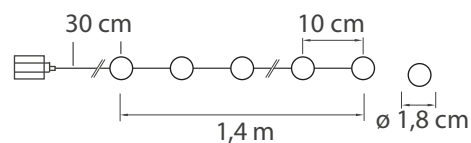

SAANA

KIDESARJA

Upea somiste kattauksiin ja koristeluun. Suosittu Saana kidepallo -koristesarja saatavissa myös omassa pöytätelineessään. LED lämmin valkoinen, ei vaihdettava, rinnankytketty. Sisältää paristot. Materiaali muovi. Johto hopea metallilanka. On/off-kytkin.

LED-LJUSSLINGA MED KRISTALLER

Vacker dekoration för dukning och som prydnad. Den omtyckta dekorationsstringen Saana med kristallbollar finns även med ett eget bordsställ. Varmvita LED-lampor, ej utbytbara, parallellkopplade. Batterier medföljer. Material: plast. Sladd av silverfärgad metalltråd. Av/på-knapp.

CRYSTAL BALL LED LIGHT CHAIN

A beautiful ornament for table setting and decoration. The popular Saana crystal ball decoration set is also available in a dedicated table rack. LED warm white, non-replaceable, parallel connection. Batteries included. Material: plastic, the cord consists of silver-coloured metal wire. On/off switch.



Saana
kidesarja/ kristallboll/ crystal ball

Nr 9477950



6 435 200 230 584





4 SEASONS



LED 15



4x AA



10 000 H

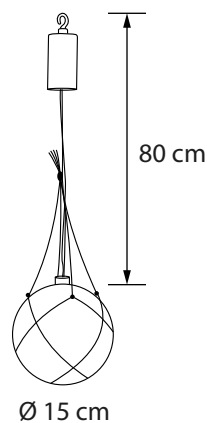

EIMI IP44

LED-KORISTEPALLO

Ulosjoiottavalla paristokotelolla varustettu, merihenkinen LED-koristepallo köysinarusomistein. LED lämmin valkoinen, ei vaihdettava. Sisältää paristot. Materiaali muovi ja naru. Johto kirkas. On/off-kytkin.

LED-DEKORATIONSBALL

Marininspirerad LED-dekorationsboll med batterifack för utomhusbruk. Dekorerad med rep. Varmvita LED-lampor, ej utbytbara. Batterier medföljer. Material: plast och rep. Genomskinlig sladd. Av/på-knapp.

LED DECORATION BALL

A maritime LED decoration ball with a water-proof outdoor battery case. Rope string ornaments. LED warm white, non-replaceable. Batteries included. Material: plastic and rope. Clear cord. On/off switch.



Nr 9477958





4 SEASONS LED WARM YELLOW 4x AA 6h TIMER 10 000 H

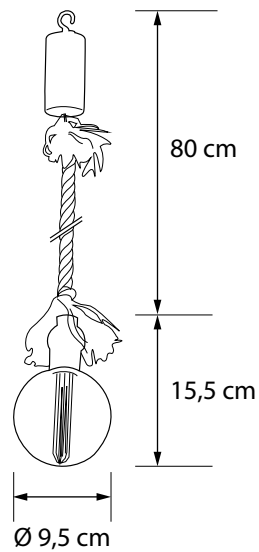

RITA IP44

LED-LAMPPU

Ulosijoitettavalla paristokotelolla varustettu LED-lamppu. Lamppu mallisuoja. Led lämmin keltainen, ei vaihdettava. Sisältää paristot. Materiaali muovi ja köysinaru.

LED-LAMPA

LED-lampa med batterifack för utomhusbruk. Formskyddad design. Varmgul LED-lampa, ej utbyttbar. Batterier medföljer. Material: plast och rep.

LED LAMP

A LED lamp with a water-proof outdoor battery case. The lamp is a protected design. LED warm yellow, non-replaceable. Batteries included. Material: plastic and rope.



Nr 9476647





4
SEASONS



IP44

LED
90



WARM
WHITE



4,5V 3,6W
IP44

10 000
H

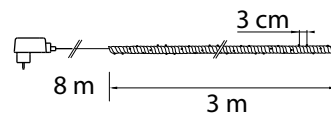

GEN IP44

LED-KÖYSI

Pitkä köysi, jossa tiheästi LED-valoja. Kieputa näyttävään asetelmaan esim. pylvään ympärille. Led lämmin valkoinen, ei vaihdettava. Johto kirkas.

LED-REP

Långt rep med många LED-lampor. Kan lindas och knyts till kreativa arrangemang, t.ex. runt en pelare. Varmvita LED-lampor, ej utbytbara. Genomskinlig sladd.

LED ROPE

A long rope with lots of interlaced LED lights. Twirl into an impressive arrangement, e.g. around a pillar. LED warm white, non-replaceable. Clear cord.



Nr 9477960





4 SEASONS



LED 78



3x AA



10 000 H

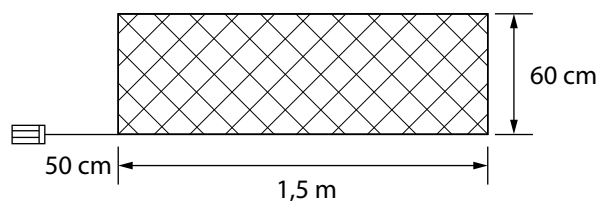

PALOMA IP44

LED-NARUVERKKO

Ulosjoiitettavalla paristokotelolla varustettu naruverkko, jonka valaisee ohut valolankasarja. Kaunis ja ilmeikäs esim. parvekkeelle levitetynä. LED lämmin valkoinen, ei vaihdettava. Sisältää paristot. Johto kirkas. On/Off-kytkin.

LED-NÄT

Ett nät av snören som lyses upp av en tunn ljusslinga och med batterifack för utomhusbruk. Vacker och uttrycksfull dekoration t.ex. för terrassen. Varmvita LED-lampor, ej utbytbara. Batterier ingår. Genomskinlig sladd. Av/på-knapp.

LED STRING NET

A string net lit up by a set of thin light threads. Water-proof outdoor battery case. Beautiful and expressive, for example, spread out on a balcony. LED warm white, non-replaceable. Batteries included. Clear cord. On/off switch.

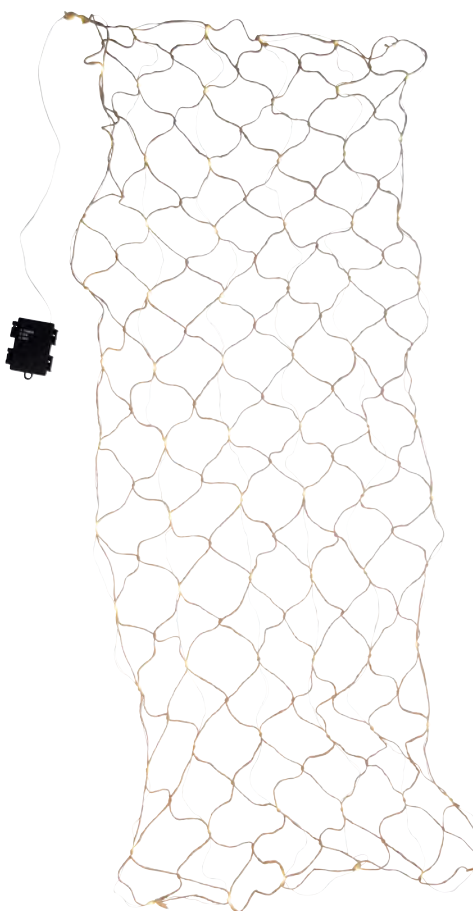

Nr 9477959



6 435200 233479





4 SEASONS



IP44

LED 50



-0- Max 32,40 m/ 300 LED

10 000 H

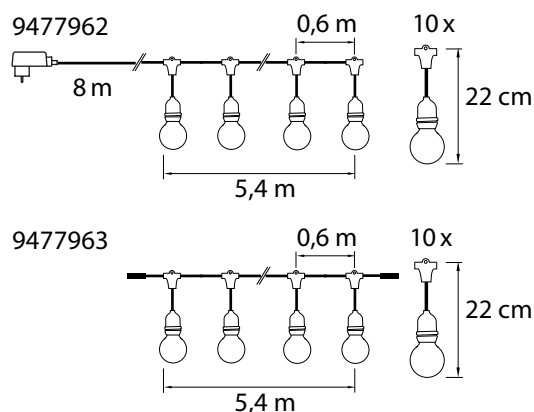

1 x 9477962 + max. 5 x 9477963, max. total 32,40 m



JARDIN IP44

JATKETTAVA LAMPPUSARJA

Upea ja monikäyttöinen lamppusarja, jossa perussarjaan voi liittää jopa viisi lisäsarjaa. Ei saa kytkeä muihin valosarjoihin tai tuotteisiin, liitännät tulee sulkea huolellisesti. LED 50 kpl: 5 kpl/lamppu, lämmin valkoinen, ei vaihdettava. Johto musta.

FÖRLÄNGBAR LAMPSLINGA

Snygg och mångsidig lampslinga som kan förlängas med upp till fem tilläggslingor. Får inte kopplas till andra typer av ljusslingor eller produkter, kopplingarna bör stängas ordentligt. 50 st. varmvita LED-lampor (5 st./lampa), ej utbytbara. Svart sladd.

AN EXTENDABLE SET OF LIGHTS

A magnificent and versatile set of lights, where the basic unit can be extended with five additional sets. Do not connect to other light sets or products. Secure the connections carefully. LED 50 pcs: 5 pcs/bulb, warm white, non-replaceable. Black cord.



31V 7,2W
IP44



Perussarja/ Batterie/ Starter set

Nr 9477962



6 4 3 5 2 0 0 2 3 5 0 8 4



4

Lisäsarja/ Extraserie/ Additional set

Nr 9477963



6 4 3 5 2 0 0 2 3 5 1 0 7



4





KEIRA IP44

LED-LAMPPUSARJA

Ilmeikäs lamppusarja kirkkailla lampuilla ja mustavalkoisella kangasjohtolla. LED lämmin valkoinen, ei vaihdettava.

LED-LAMPSLINGA

Uttrycksfull lampslinga med genomskinliga lampor och svartvit tygsladd. Varmvita LED-lampor, ej utbytbara.

LED LAMP SET

An expressive set of lamps with a decorative black-and-white fabric cord. LED warm white, non-replaceable.

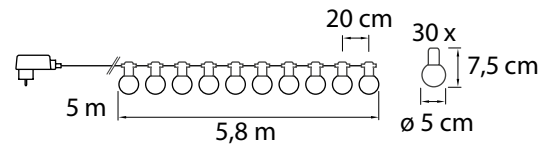

Mustavalkoinen kangasjohto.
Svartvit tygsladd.
Black-and-white fabric cord.

Nr 9477979





KAJO IP44

LED-LAMPPUSARJA

Kaunis lamppusarja vaihdettavilla E27-kantaisilla lampuilla, 0,5W. LED lämmin valkoinen, vaihdettava. Varalampun nro 9477322. Soveltuu vain Kajo -sarjaan. Materiaali muovi, lamppu lasia. Johto valkoinen.

LED-LAMPSLINGA

Vacker lampslinga med utbytbara lampor med E27-sockel, 0,5 W. Varmvita LED-lampor, utbytbara. Reservlampans nr 9477322. Passar endast för ljusslingan Kajo. Material: plast, lampor av glas. Vit sladd.

LED LAMP SET

A beautiful set of lights with replaceable E27 0.5 W bulbs. LED warm white, replaceable. Spare LEDs no. 9477322. Material: plastic, glass lamps. White cord.

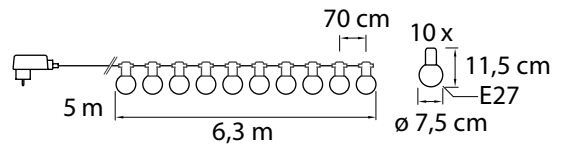

Kajo
Nr 9477819



Varalamppu/ Sparlampa/
Spare bulb 0,5W E27
Nr 9477322



Vaihdettavat lamput.
Utbytbara lampor.
Replaceable bulbs.



HUVI IP44

LED-LAMPPUSARJA

Näyttävä industrial-henkinen lamppusarja. Klipsikiinnitys lampun kannassa. LED lämmin valkoinen, ei vaihdettava. Materiaali muovi ja metalli. Johto musta.

LED-LAMPSLINGA

Spännande, industriliknande lampslinga. Klämfäste vid lampans sockel. Varmvita LED-lampor, ej utbytbara. Material: plast och metall. Svart sladd.

LED LAMP SET

An impressive industrial-style set of lamps. Clip attachment in the base of the lamp. LED warm white, non-replaceable. Material: metal and plastic. Black cord.

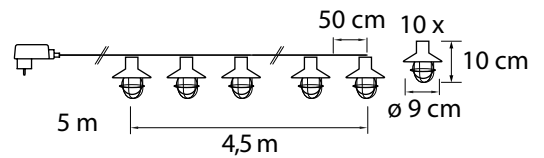

Nr 9477941





TALLILYHTY IP44

LED-LYHTY

Klassinen antiikkimusta tallilyhty, jossa irroitettava lyhtysuojus. Pienet kiinnityskoukut. LED 10 kpl lämmin valkoinen, ei vaihdettava. Materiaali metalli ja muovi. Johto musta.

LED-OLJELYKTA

Klassisk, antiks svart oljelykta med avtagbart hölje och små fästкроkar. Varmvita LED-lampor, ej utbytbara. Material: metall och plast. Svart sladd.

LED LANTERN

A classic black antique lantern with a removable cover. Small attachment hooks. LED warm white, non-replaceable. Material: metal and plastic. Black cord.

4 SEASONS
IP44
LED 10
WARM WHITE
DC
30V 3VA IP44
10 000 H

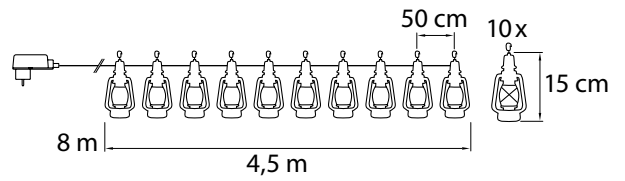

Nr 9476729



6 435200 181190



Koristevalot | Dekorationsbelysning | Decorative Lights 2019

Kevät | Vår | Spring



Airam Electric Oy Ab
P.O.Box175
(Sementtitehtaankatu 6)
FI-04201 Kerava, Finland
Tel. +358 207 545 600
Fax +358 207 545 623
info@airam.fi
International customer
service: export@airam.fi
www.airam.fi

Airam AB
Uppköparvägen 7
120 44 Årsta, Sverige
Telefon +46 8 72 244 20 (växel)
Fax +46 8 60 283 00
info@airam.se
www.airam.se

© Airam Electric Oy Ab, 2018

Pidätämme oikeuden muutoksiin.
Vi förbehåller oss rätten till eventuella
ändringar och tryckfel.
Product related changes possible.



AIRAM