

Life IN Light

MEGAMAN®

Belysnings- katalog 2015 / 16



1800K - 2800K
Dim to WARM



100% 60% 20%
Step Dimming



LED by
MEGAMAN®

www.megaman.dk

Spændende 2015 nyheder fra MEGAMAN®

SMART LIGHTING

Som en af verdens førende producenter af lyskilder er Megaman® ledende på udvikling og design af Smart Lighting, som kombinerer høj lyskvalitet med intelligente styringsenheder.



ingenium®
BLU

Blue Tooth

Megaman's bluetooth pærer har indbygget bluetooth modul som kan kommunikere direkte med smartphone eller tablet, hvorfra man enkeltvis, eller i grupper, kan anvende tænd/sluk funktion, dæmpning eller timer-funktion mv. Lyskontrol på få sekunder!!

Side 4-5



ingenium®
RF

WIFI

Det ultimative lyskontrollsystem baseret på WIFI med adgangsmulighed fra hvilket som helst sted i verden. Tænd/sluk, dæmpning, timer funktion, foruddefinerede lysscener mv. Anvender RF (radio frekvens) moduler til at styre lyskilderne dvs. eksisterende dæmpbare Megaman LED lyskilder kan anvendes i opsætningen. Betjenes via smartphone, tablet eller fjernbetjening

Side 6-7



Side 8

LED Filament

Unikt design indenfor LED, som genskaber atmosfæren af de gamle glødetrædspærer, men hvor energi effektiviteten er i top og således giver både et godt lys og sparer på strømmen.

Fås både som almindelige Kerte, Krone og Classic pære og også i Globe pærer i forskellige farvetemperaturer – med og uden dæmpningsfunktion.



Side 9



Dim to **WARM**

Årets varmeste nyhed!

Nyt dæmpningskoncept, hvor farvetemperaturen i lyskilderne dæmpes sammen med dæmpning af lumen fra pærene – og således dæmpes farvetemperaturen fra 2800 kelvin til 1800 kelvin. Det vil sige fra hvidt almindeligt lys til varmt og hyggelig belysning med dæmpet farvetemperatur, hvor man ser samme lyskarakteristika som for glødepærer og halogen.



Side 10

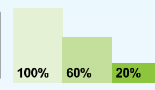

Step Dimming



Step Dimming

3-trins dæmpningssystem indbygget i pærene!

Med et kontaktryk dæmpes lyskilden fra 100% til 60% og ned til 20% - uden brug af normal lysdæmper, den er nemlig indbygget i pæren!

Velegnet til alle lamper og indbygningsspot mv. hvor der ikke er etableret lysdæmper.



MEGAMAN®s populære A+ Economy-serie er nu udvidet med en række spændende nyheder!



LED Kerte
LC0403.5 / 3,5W E14 / 250 lumen
Varenr. 178300



LED Kerte
LC1105.5 / 5,5W E14 / 470 lumen
Varenr. 178360



LED Krone
LG2603.5 / 3,5W E14 / 250 lumen
Varenr. 178301



LED Krone
LG2603,5 / 3,5W E27 / 250 lumen
Varenr. 178302



LED Krone
LG5205.5 / 5,5W E14 / 470 lumen
Varenr. 178343



LED Krone
LG5205.5 / 5,5W E27 / 470 lumen
Varenr. 178344



LED Classic
LG2205.5 / 5,5W E27 / 470 lumen
Varenr. 178304



LED Classic
LG2509.5 / 9,5W E27 / 810 lumen
Varenr. 178305



LED Classic
LG2311 / 11W E27 / 1055 lumen
Varenr. 178306



LED Globe
LG3111 / 11W E27 / 1055 lumen
Varenr. 178244



LED PAR16
LR2104DG-WFL / 4W GU10
250 lumen / 560 cm, 35°
Varenr. 178307



LED MR16
ER2404DG-WFL / 4W GU5.3
220 lumen / 260 cd, 36°
Varenr. 178325



LED MR16
ER2404DG-WVFL / 5W GU5.3
330 lumen / 240 cd, 60°
Varenr. 178236



LED R50
LR2603.5-SWFL / 3,5W E14
250 lumen / 120 cd
Varenr. 178313



LED R63
LR2407.5-SWFL / 7,5W E27
600 lumen / 230 cd
Varenr. 178314



LED R80
LR4307-SWFL / 7W E27
520 lumen / 230 cd
Varenr. 178348



LED GU9
LU0502.4 / 2,4W GU9 / 190 lumen
Varenr. 178350



LED PUK
LR2205 / 5W GX53 / 300 lumen
Varenr. 178311



SMART BOX

- **Altid konkurrencedygtige markedspriser**
- **Alle produkter leveres i Smart Box (blister og æske kombineret)**
- **15.000 timers levetid**
- **Ej dæmpbar**

INGENIUM® BLU

Nem og prisbillig Bluetooth® 4.0 løsning på LED lyskilder



Nemt og hurtigt!

For at anvende Megaman Bluetooth produkterne skal man blot:

1. Download gratis software
2. Sæt lyskilden i og forbind trådløst med App
3. Nu har du kontrol på lyskilden/lyskilderne



Bluetooth version	4.0
Rækkevide	10 meter
Max antal pærer/moduler på samme tid	4 stk. i hver gruppe Dog 8 stk for iOS 8.0 ->
Max antal grupper	8 grupper pr. app
Max antal scene-indstillinger pr. gruppe	4 scener i hver gruppe
Kontrol unit	Mobilenhed eller tablet med iOS eller Android app
Anvendelse	Husholdning, showroom, lounge, funktionsrum, reception osv.



220-240V 50/60 Hz 11W E27

Varenr.	Produktnavn	Lumen (lm)	Farve temp. (K)	Levetid (timer)	Diameter (mm)	Længde (mm)	Vægt (g)	Dæmpbar	Energi mærke	Kolli	EAN kode / MM nummer
178351	LG2311dBT	810	2800	25000	65	125	120	100-1%	A+	1/60	4892657048285



220-240V 50/60 Hz 8W GU10

Varenr.	Produktnavn	Lysvinkel (°)	Lumen (lm/cd)	Farve temp. (K)	Levetid (timer)	Diameter (mm)	Længde (mm)	Vægt (g)	Dæmpbar	Energi mærke	Kolli	EAN kode / MM nummer
178354	LR3808dBT-WFL	WFL (35°)	540/750	2800	25000	50	65	80	100-1%	A	1/60	4892657048292



220-240V 50/60 Hz 13W 900 lm 69 lm/W IP20

BESTILLINGSVARE

Hvid

Varenr.	Produktnavn	Lysvinkel (°)	Farve temp. (K)	Levetid (timer)	Power Factor (λ)	Diameter (mm)	Længde (mm)	Hul diameter (mm)	Vægt (g)	Dæmpbar	Kolli	EAN kode / MM nummer
178355	F26400RC-dBT	60	2800	25000	> 0.9	110	78	85	157	100-1%	1/24	4892657048308



INGENIUM® BLU Mobile App
Download nu på



iOS enheder

- Anbefalet iOS version 6.0 eller derover
- iPhone 4S eller nyere
- iPad: 3. generation eller derover (generation gældende for tidlige 2012 modeller)
- iPod Touch (5. generation), iPad Mini (alle modeller)

Android enheder

- Anbefalet Android version 4.3 eller derover
- Samsung Galaxy S4, Nexus 7 (2013)

Praktisk Demo-display til test af Bluetooth Classic pære. Kontakt vor salgsafdeling for aftale om Demo-display.

Download dansk brugsanvisning for Bluetooth styring via www.megaman.dk eller scan QR kode her:



Dansk brugervejledning



INGENIUM® RF

Megaman introducerer Wifi baseret lyskontrol system. Nem installation og giver avancerede muligheder for lysstyring i hjemmet eller i virksomheden.



Med Ingenium RF får man ikke alene en avanceret løsning lokalt, men kan også tilgå systemet hvor som helst fra i verden, dvs. er man på rejse kan man nemt og enkelt via sin App til mobil eller tablet, gå ind på systemet og aktivere lyssætning eller ændre på dette. Til daglig anvendes enten smartphone, tablet eller tilhørende fjernbetjening.

For at anvende Ingenium RF skal man installere en Megaman RF Gateway, som er en enhed mellem ens WIFI router og de RF moduler som styrer lysgrupperne. Gateway'en kan betjenes med gratis downloaded App eller Megaman RF fjernbetjening. Der skal installeres/sammenkobles et trådløst RF-modul med de lyspunkter/lysgrupper man ønsker at betjene, dvs. f.eks skal en lyse krone i stuen med 6-8 pærer forbindes med ét RF-modul, som så styrer alle pærerne. Eksisterende dæmpbare lyskilder vil i de fleste tilfælde kunne virke med systemet, således man ikke skal købe nye lyskilder.

Hvordan virker det

I hele verden



Lokalt

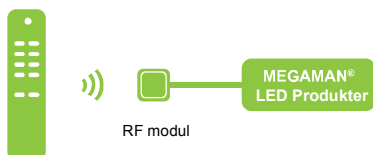

Fjernbetjening

Funktioner:

- Tænd/sluk
- Lysdæmpning
- Timer-funktion, indstil tænd/sluk på fremtidige datoer
- Scenario programmering

Virker med følgende smartphone or tablet versioner:

iOS enheder

- Anbefalet iOS version 6.0 eller derover
- iPhone 4S eller nyere
- iPad: 3. generation eller derover (generation gældende for tidlige 2012 modeller)
- iPod Touch (5. generation), iPad Mini (alle modeller)

Android enheder

- Anbefalet Android version 4.3 eller derover
- Samsung Galaxy S4, Nexus 7 (2013)

Megaman *Ingenium*® WIFI system:

- Hurtig og enkel installation
- Kan anvendes over større arealer
- Nyttige indstillingsmuligheder som feks. timer funktioner mv.
- Reel strømbesparelse ved anvendelse af dæmpfunktion

Trådløs teknologi	Radio Frequency (433MHz)
Dækning (Gateway til RF modul)	Indendørs: op til 20m Udendørs: op til 35m
Max antal RF moduler	Styret via Gateway: Ubegrænset Styret via fjernbetjening/vægstyring: 48 moduler
Kontrol enhed	Mobilenhed eller tablet med iOS eller Android app
Network topologi	Star
Anvendelse	Restauranter, hotel, butikker, lounge, hjem, kontor osv.



Gateway

En Gateway kan forbinde op til 48 RF moduler, som hver for sig foretager tænd/sluk, dæmpning og timer funktion. Rækkevide til RD modul er ca. 35 meter udendørs og 20 meter indendørs.

Varenr.	Produktnavn	Spænding (V)	Radio Frekvens	TX (Sender)	App kontrol	Lysstyrke kontrol	Antal lysstyrker	Max kanaler til indstilling	Låse mulighed	Dimensioner (mm)	EAN kode
178507	RFG01-WH	12V AC adaptor	433.92MHz	Ja	Ja	Ja	8 x 3 indstilling	8 x 6 kanaler	Ja	H41 x B128 x L122	4892657051063



RF modul

Trådløst styreenhed med dæmpfunktion, som hvert kan belastet med 6 enheder/ lyskilder og i alt 100W belastning pr. modul, dvs. feks 6 stk. 11w LED pærer.

Varenr.	Produktnavn	Spænding (V)	Load (W)	Radio frekvens	RX (Modtager)	Dæmp	Fjernbetjent	Max. antal lyskilder	Dæmpbar LED	Lav energi Halogen	Gløde pærer	Dimensioner (mm)	EAN kode
178509	RFM0106-WH	220-240	100	433.92MHz	Ja	Ja	Ja	6	Ja	Ja	Ja	H19 x B69 x L49	4892657051070



Fjernbetjening

Praktisk håndholdt fjernbetjening til hele familien eller flere brugere, som giver umiddelbart kontrol af alle RF moduler. Kan foretage tænd/sluk og dæmpning mv.

Varenr.	Produktnavn	Spænding (V)	Radio Frekvens	TX (Sender)	Dæmp kontrol	Fjernbetjent	Lysstyrke kontrol	Antal lysstyrke	Max kanaler til indstilling	Dimensioner (mm)	EAN kode
178508	RFH01-WH	3V batteri (CR2032)	433.92MHz	Ja	Ja	Ja	Ja	1 lysstyrke	4 x 4 kanaler	H140 x B37 x L14	4892657051087



Vægkontakt

Vægkontakt til trådløs kommunikation med RF moduler. Skal blot opsættes med 4 skruer og fungerer med batterier, dvs. ingen strømføring.

Varenr.	Produktnavn	Spænding (V)	Radio Frekvens	TX (Sender)	Dæmp kontrol	Fjernbetjent	Lysstyrke kontrol	Antal lysstyrke	Max kanaler til indstilling	Dimensioner (mm)	EAN kode
178510	RFW01-WH	3V batteri (CR2032)	433.92MHz	Ja	Ja	Ja	Ja	1 lysstyrke	4 x 4 kanaler	D13.5 x B88 x L88	4892657051858



Ny serie lyskilder fra Megaman, som med nyeste LED teknologi skaber dekorativ belysning som minder om de gamle gløde- og kultrådspærer, men er designet med energi-effektiv LED teknologi.

De nye Megaman Filament pærer fås med og uden dæmpfunktion og i forskellige farvetemperaturer; hhv. varmvid 2700 Kelvin og den meget varme 2200 Kelvin. Sidstnævnte produceres endvidere med guldfarvet glas, så man opnår den ultimative dekorative hyggebelysning.

Filamentpære til erstatning for glødepærer, med samme farvetemperatur på 2700K. Med og uden dæmp.



Smart Series | 220-240V | 50/60Hz

2700K

Varenr.	Produkt navn	Type	Sokkel	Watt (W)	Lumen (lm)	Farve Temp.	Levetid (timer)	Diameter (mm)	Længde (mm)	Vægt (g)	Dæmpbar	Energi mærke	Kolli	EAN kode / MM nummer
178401	LC1503.2dCS	2	E14	3.2	220	2700K	15000	35	113	31	100 - 10%	A+	10/60	4892657 058292
178403	LG6205.5dCS	4	E27	5.5	470	2700K	15000	60	118	47	100 - 10%	A+	10/60	4892657 052459
178400	LC1403CS	1	E14	3.0	250	2700K	15000	36	107	14	Nej	A+	10/60	4892657 057669
178402	LG6104.8CS	3	E27	4.8	470	2700K	15000	60	107	31	Nej	A+	10/60	4892657 052442



E14 - Varenr. 178981
E27 - Varenr. 178983



E14 - Varenr. 178982
E27 - Varenr. 178984

Tilbehør

Sokkel afdækning i børstet stål og messing kan fås til 178401 (E14) og 178403 (E27).

Hyggelig og harmonisk belysning med lysfarve i 2200 kelvin.

Farvetemperatur på 2200K og produceret i gyldent tonet glas, som giver en meget dekorativ belysning.



Smart Series | 220-240V | 50/60Hz

2200K

Varenr.	Produkt navn	Type	Sokkel	Watt (W)	Lumen (lm)	Farve Temp.	Levetid (timer)	Diameter (mm)	Længde (mm)	Vægt (g)	Dæmpbar	Energi mærke	Kolli	EAN kode / MM nummer
178404	LG6703GD	5	E27	3	210	2200	15000	75	137	48	Nej	A+	10/60	4892657 058789
178405	LG6803GD	6	E27	3	210	2200	15000	95	138	60	Nej	A+	3/24	4892657 058765
178406	LG6903GD	7	E27	3	210	2200	15000	125	174	104	Nej	A+	3/24	4892657 058772
178407	LG7003GD	8	E27	3	210	2200	15000	58	132	43	Nej	A+	10/60	4892657 058796



Dim to WARM

Ny dæmpnings teknologi, der giver samme varme belysning som gløde- og halogenpærer

Megaman har udviklet en hel produktserie med Dim to Warm teknologi, og giver mulighed for at dæmpe belysningen samtidig med farvetemperaturen. Således dæmpes fra 100->10% og fra 2700/2800K->1800K.



Smart Series | 1800K - 2800K

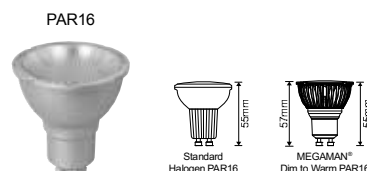

Varenr.	Produkt navn	Watt (W)	Sokkel	Spænding (V)	Frekvens (Hz)	Lumen (lm/cd)	Lys vinkel (°)	Farve temp. (K)	Levetid (timer)	Diameter (mm)	Længde (mm)	Vægt (g)	Energi mærke	Kolli	EAN kode / MM nummer
178500	LR2106wDG-WFL	6	GU10	220-240	50/60	380/480	35	2800K	25000	50	57	64	A	10/60	4892657060188



Smart Series | 1800K - 2700K



Type	Varenr.	Produkt navn	Watt (W)	Sokkel	Spænding (V)	Frekvens (Hz)	Lumen (lm)	Farve temp. (K)	Levetid (timer)	Diameter (mm)	Længde (mm)	Vægt (g)	Energi mærke	Kolli	EAN kode / MM nummer
1	178501	LC1106wCS	6	E14	220-240	50/60	470	2700K	25000	40	106	60	A+	10/60	4892657052312
2	178502	LG5206w	6	E14	220-240	50/60	470	2700K	25000	45	80	55	A+	10/60	4892657052350
2	178503	LG5206w	6	E27	220-240	50/60	470	2700K	25000	45	80	56	A+	10/60	4892657052343
3	178504	LG2310.5w	10.5	E27	220-240	50/60	810	2700K	25000	65	125	122	A+	10/60	4892657052374

3-trins dæmpbare lyskilder med indbygget dæmpfunktion

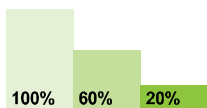
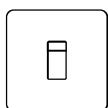

Step Dimming

Tre justerbare lysstyrker: 100%, 60% and 20%

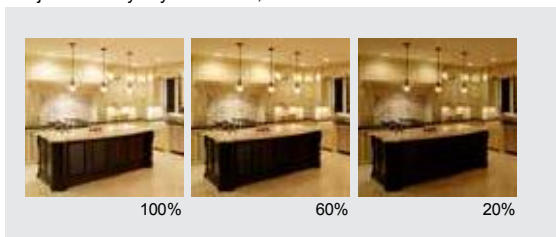

- Lyskilder med indbygget trinvis lysdæmpning.
- Med en almindelig afbryder dæmpes pæren fra 100% -> 60% -> 20 %
- Sæt et ubegrænset antal pærer op til lysdæmpning på samme afbryder, det er nemlig tænd/sluk funktionen som styrer dæmpningen.



Dæmp dine LED lyskilder med en almindelig afbryder.

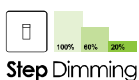

Step Dimming

Smart Series | 220-240V | 50/60Hz

Varenr.	Type	Produktnavn	Watt (W)	Sokkel	Lysvinkel (°)	Lumen (lm/cd)	Farve temp. (K)	Levetid (timer)	Diameter (mm)	Længde (mm)	Vægt (g)	Energi mærke	Kolli	EAN kode / MM nummer
178505	1	LR2106sDG-WFL	6	GU10	40	360/480	2800K	25000	50	57	46	A	10/60	4892657052220
178506	2	LG2509.5s	9.5	E27	330	810	2800K	25000	60	115	86	A+	10/60	4892657052169

ClassicA60



PAR16



1

8



2



3



4



1



220-240V | Kerte

Varenr.	Produkt navn	Type	Sokkel	Watt (W)	Lysstrøm (lm)	Farve (K)	Lysvinkel (°)	Levetid (hrs)	Diameter (mm)	Længde (mm)	Vægt (g)	Dæmp	Energi mærke	Kolli	EAN kode / MM nummer
178360	LC1105.5	1	E14	5,5	470	2800	330	15000	40	106	45	Nej	A+	10/60	4892657 045390
178224	LC0404dCSv2	2	E14	4	220	2800	330	25000	35	100	39	Ja	A+	10/60	4892657 036091
178226	LC0803.5dCS	2	E14	3.5	250	2800	330	25000	35	100	40	Ja	A+	10/60	4892657 043167
178300	LC0403.5	3	E14	3.5	250	2800	330	15000	35	100	34	Nej	A+	10/60	4892657 038774
178225	LC0505dv2	3	E14	5	270	2800	330	25000	41	105	55	Ja	A+	10/60	4892657 043679
178323	LC0704CS	4	E14	4	400	2800	330	25000	35	117	37	Nej	A+	10/60	4892657 043181
178330	LC0805dCS	4	E14	5	400	2800	330	25000	35	100	57	Ja	A+	10/60	4892657 043174

Dæmpbar lyskilder er markeret med dette symbol



P45



220-240V | Krone

Varenr.	Produktnavn	Type	Sokkel	Watt (W)	Lysstrøm (lm)	Farve (K)	Lysvinkel (°)	Levetid (timer)	Diameter (mm)	Længde (mm)	Vægt (g)	Dæmp	Energi mærke	Kolli	EAN kode / MM nummer
178227	LG2603.5d	1	E14	3.5	250	2800	330	25000	45	84	36	Ja	A+	10/60	4892657036121
178301	LG2603.5	2	E14	3.5	250	2800	330	15000	45	84	32	Nej	A+	10/60	4892657038958
178302	LG2603.5	2	E27	3.5	250	2800	330	15000	45	77	33	Nej	A+	10/60	4892657038965
178265	LG2603.5d	3	E27	3.5	250	2800	330	25000	45	87	56	Ja	A+	10/60	4892657043082
178228	LG4003.5dCS	4	E14	3.5	250	2800	330	25000	45	84	32	Ja	A+	10/60	4892657043365
178229	LG1907dv2	5	E27	7	400	2800	330	25000	45	93	61	Ja	A	10/60	4892657036503
178238	LG1907dv2	5	E14	7	400	2800	330	25000	45	99	58	Ja	A	10/60	4892657036497
178340	LS0303.5d	6	E14	3.5	-	2800	-	25000	45	84	42	Ja	-	10/60	4892657047516
178343	LG5205.5	7	E14	5.5	470	2800	270	15000	45	80	53	Nej	A+	10/60	4892657048063
178344	LG5205.5	7	E27	5.5	470	2800	270	15000	45	80	53	Nej	A+	10/60	4892657048193
178346	LG4303.5	8	E14	3.5	250	2800	360	25000	45	84	30	Nej	A+	10/60	4892657043389
178310	LG2402d	9	E14	2	100	2800	330	25000	26	57	17	Ja	A+	20/120	4892657038491



IP54

220-240V | Krone - Farvede pærer

Varenr.	Produktnavn	Type	Sokkel	Watt (W)	Lysstrøm (lm)	Farve (K)	Farve	Lysvinkel (°)	Levetid (timer)	Diameter (mm)	Længde (mm)	Vægt (g)	Dæmp	Energi mærke	Kolli	EAN kode / MM nummer
178370	LG4302R	1	B22	2	-	-	Rød	330	15000	45	78	26	Nej	-	10/60	4892657061307
178371	LG4302G	2	B22	2	-	-	Grøn	330	15000	45	78	26	Nej	-	10/60	4892657061314
178372	LG4302B	3	B22	2	-	-	Blå	330	15000	45	78	26	Nej	-	10/60	4892657061321
178373	LG4302Y	4	B22	2	-	-	Gul	330	15000	45	78	26	Nej	-	10/60	4892657061338
178374	LG4302W	5	B22	2	130	3000	Hvid	330	15000	45	78	26	Nej	A+	10/60	4892657061345

P55
P60
P70



220-240V | Classic

Varenr.	Produkt navn	Type	Sokkel	Watt (W)	Lysstrøm (lm)	Farve (K)	Lysvinkel (°)	Levetid (timer)	Diameter (mm)	Længde (mm)	Vægt (g)	Dæmp	Energi mærke	Kolli	EAN kode / MM nummer
178304	LG2205.5	1	E27	5.5	470	2800	330	15000	55	104	59	Nej	A+	10/60	4892657 038361
178305	LG2509.5	1	E27	9.5	810	2800	330	15000	60	115	75	Nej	A+	10/60	4892657 038262
178306	LG2311	1	E27	11	1055	2800	330	15000	65	125	103	Nej	A+	10/60	4892657 038286
178201	LG2207d	2	E27	7	470	2800	330	25000	55	104	101	Ja	A+	10/60	4892657 030563
178203	LG1610dv2	2	E27	10	650	2800	330	25000	60	117	104	Ja	A+	10/60	4892657 036213
● 178204	LG2310.5d	3	E27	10.5	810	2800	330	25000	65	125	145	Ja	A+	10/60	4892657 041569
178205	LG0408rv2	4	E27	8	420	2800	330	25000	60	118	82	Nej	A+	10/60	4892657 033311
178341	LS0405d	5	E27	5	-	2800	-	25000	55	104	81	Ja	-	10/60	4892657 047530
178324	LG4106dCS	6	E27	6	470	2800	330	25000	55	104	75	Ja	A+	10/60	4892657 043211
● 178345	LG3816.5	7	E27	16.5	1521	2800	330	25000	71	139	218	Nej	A+	6/12	4892657 043198
● 178347	LG4405.5	8	E27	5.5	470	2800	360	25000	55	100	59	Nej	A+	10/60	4892657 044027
● 178342	LG4508	9	E27	8	810	2800	360	25000	60	107	85	Nej	A+	10/60	4892657 043204
● 178362	LG3713d	10	E27	13	1055	2800	330	25000	65	126	177	Ja	A+	10/60	4892657 042313

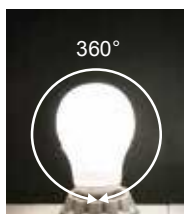

- **360° belysning**
I stand til at afgive lys i alle retninger
- **Brudsikkert design**
LED Classice 360° er med brudsikker glasoverflade, som sikrer at glasskår ikke spredes ved evt. ødelæggelse af pæren

Dæmpbar lyskilder er markeret med dette symbol

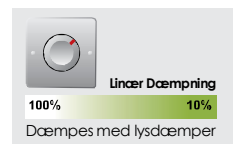

GLOBE



2



1



220-240V | Globe

Varenr.	Produktnavn	Type	Sokkel	Watt (W)	Lysstrøm (lm)	Farve (K)	Lysvinkel (°)	Levetid (hrs)	Diameter (mm)	Længde (mm)	Vægt (g)	Dæmp	Energi mærke	Kolli	EAN kode / MM nummer
178244	LG3111	1	E27	11	1055	2800	330	15000	98	148	153	Nej	A+	6/24	4892657 040166
● 178326	LG3110.5d	1	E27	10.5	810	2800	330	25000	98	148	190	Ja	A+	6/24	4892657 043723
● 178349	LG5013d	1	E27	13	1055	2800	330	25000	120	174	215	Ja	A+	6/24	4892657 046472
● 178352	LG5010.5	1	E27	10.5	810	2800	330	25000	120	174	209	Ja	A+	6/24	4892657 045239
● 178353	LG3113d	1	E27	13	1055	2800	330	25000	98	148	190	Ja	A+	6/24	4020856 210620
178043	LG0808dv2	2	E27	8	420	2800	330	25000	120	165	215	Ja	A+	6/24	4892657 031461

Dæmpbar lyskilde er markeret med dette symbol

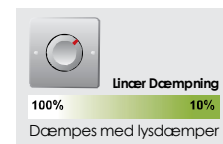

PAR16



220-240V | GU10 / PAR16

Varenr.	Produktnavn	Type	Sokkel	Watt (W)	Lysstrøm (lm/cd)	Farve (K)	Lysvinkel (°)	Levetid (hrs)	Diameter (mm)	Længde (mm)	Vægt (g)	Dæmp	Energi mærke	Kolli	EAN kode / MM nummer
178279	LR2307dDG-WFL	1	GU10	7	650/500	2800	35	25000	50	57	67	Ja	A+	10/60	4892657 039733
178307	LR2104DG-WFL	2	GU10	4	250/560	2800	35	15000	50	57	32	Nej	A+	10/60	4892657 038682
178036	LR1204-FL	3	GU10	4	200/800	2800	24	20000	50	55	40	Nej	A+	10/60	4892657 030341
178038	LR1506-35H24D	4	GU10	6	300/1300	2800	24	25000	50	64	70	Nej	A	10/60	4892657 032871
178039	LR1506-35H35D	4	GU10	6	300/600	2800	35	25000	50	64	70	Nej	A	10/60	4020856 273720
178206	LR1204dLNv2-WFL	5	GU10	4	250/600	2800	35	25000	50	61	61	Ja	A+	10/60	4892657 035971
178208	LR1206dLNv2-WFL	5	GU10	6	300/750	2800	35	25000	50	61	70	Ja	A+	10/60	4892657 035964
178207	LR1204dDGv2-VWFL	6	GU10	4	280/200	2800	60	25000	50	57	34	Ja	A+	10/60	4892657 036145
178209	LR1206dDGv2-VWFL	6	GU10	6	410/240	2800	60	25000	50	57	66	Ja	A+	10/60	4892657 036152
178210	LR2008d-50H24D	7	GU10	8	400/1700	2800	24	25000	50	70	98	Ja	A+	10/60	4892657 035940
178211	LR2008d-50H35D	7	GU10	8	400/900	2800	35	25000	50	70	98	Ja	A+	10/60	4892657 036169

LR1206dDGv2-WFL

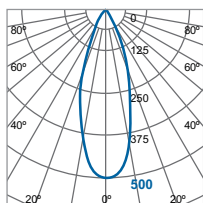

m	Lux	Ø cm
0.5	2000	32
1	500	63
1.5	222	95
2	125	126

Beam angle = 35°

LR2307dDG-WFL

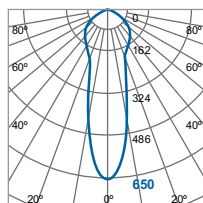

m	Lux	Ø cm
0.5	2600	32
1	650	63
1.5	289	95
2	163	126

Beam angle = 35°

LR2104DG-WFL

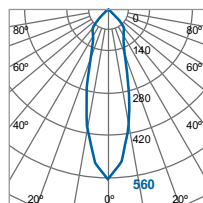

m	Lux	Ø cm
0.5	2240	32
1	560	63
1.5	249	95
2	140	126

Beam angle = 35°

Dæmpbar lyskilder er markeret med dette symbol



MR16 MR11



2

3

4

1

AC/DC12V | MR16

Varenr.	Produktnavn	Type	Sokkel	Watt (W)	Lysstrøm (lm/cd)	Farve Temp. (K)	Lysvinkel (°)	Levetid (hrs)	Diameter (mm)	Længde (mm)	Vægt (g)	Dæmp	Energi mærke	Kolli	EAN kode / MM nummer
178233	ER0604-FL	1	GU5.3	4	180/650	2800	24	25000	50	45	32	Nej	A	10/60	4892657024760
178022	ER1006-35H36D	2	GU5.3	6	240/600	2800	36	25000	50	51	60	Nej	A	10/60	4892657028867
178046	ER1006-35H24D	2	GU5.3	6	240/1300	2800	24	25000	50	51	60	Nej	A	10/60	4892657028720
178325	ER2404DG-WFL	3	GU5.3	4	260/220	2800	36	15000	50	47	28	Nej	A	10/60	4892657043747
178236	ER2405DG-VWFL	3	GU5.3	5	320/240	2800	60	15000	50	47	28	Nej	A	10/60	4892657043808
178361	ER3207.5d	4	GU5.3	7.5	450/1100	2800	36	25000	50	56	70	Ja	A	10/60	4892657053128



5

AC/DC12V | MR11

Varenr.	Produktnavn	Type	Sokkel	Watt (W)	Lysstrøm (lm/cd)	Farve Temp. (K)	Lysvinkel (°)	Levetid (hrs)	Diameter (mm)	Længde (mm)	Vægt (g)	Dæmp	Energi mærke	Kolli	EAN kode / MM nummer
178215	ER2304-20H36D	5	GU4	4	230/600	2800	36	25000	35	42	24	Nej	A+	20/20	4892657035933

ER2304-20H36D

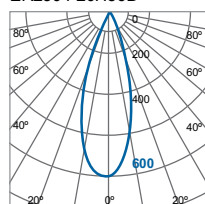

m	Lux	Ø cm
0.5	2400	32
1	600	65
1.5	267	97
2	150	130

Beam angle = 36°

ER2404DG-WFL

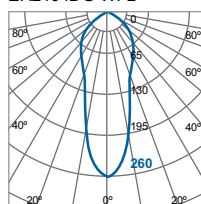

m	Lux	Ø cm
0.5	1040	32
1	260	65
1.5	116	97
2	65	130

Beam angle = 36°

ER1006-35H24D

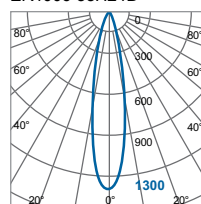

m	Lux	Ø cm
0.5	5200	21
1	1300	43
1.5	578	64
2	325	85

Beam angle = 24°

ER1006-35H36D

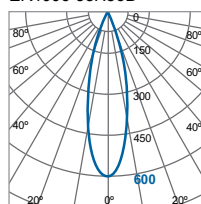

m	Lux	Ø cm
0.5	2400	32
1	600	65
1.5	267	97
2	150	130

Beam angle = 36°

Dæmpbar lyskilder er markeret med dette symbol

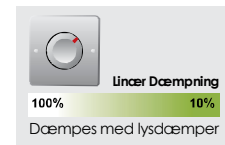

PAR20
PAR30
PAR38



2

3

4

5

1



220-240V | PAR20 / 30 / 38

Varenr.	Produktnavn	Type	Sokkel	Watt (W)	Lysstrøm (lm/cd)	Farve Temp. (K)	Lysvinkel (°)	Levetid (timer)	Diameter (mm)	Længde (mm)	Vægt (g)	Dæmp	Energi mærke	Kolli	EAN kode / MM nummer
178321	LR3010.5-WFL	1	E27	10.5	700/850	2800	35	15000	95	88	103	Nej	A	10/60	4020856 172429
178320	LR2906-WFL	2	E27	6	350/470	2800	35	15000	63	90	60	Nej	A+	10/60	4892657 043242
178009	LR0915-75H30D	3	E27	15	630/2200	2800	30	30000	121	133	458	Nej	A	6/24	4892657 022704
178016	LR0920-25H25D	3	E27	20	1200/6800	2800	25	30000	121	133	485	Nej	A	6/24	4892657 025101
178037	LR0920R9-25M45D	3	E27	20	900/5000	2800	25	30000	111	133	485	Nej	A	6/24	4892657 030525
178322	LR3215.5-WFL	4	E27	15.5	950/1500	2800	35	15000	120	132	204	Nej	A	6/24	4892657 043105
178133	LR1412d-75H30D	5	E27	12	600/2300	2800	30	30000	95	88	260	Ja	A	6/24	4892657 030624

LR3010.5-WFL

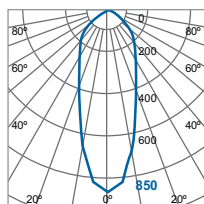

m	Lux	Ø cm
0.5	3400	32
1	850	63
1.5	378	95
2	213	126

Beam angle = 35°

LR1412d-75H30D

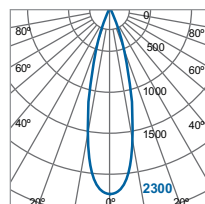

m	Lux	Ø cm
0.5	9200	27
1	2300	54
1.5	1022	80
2	575	107

Beam angle = 30°

LR2906-WFL

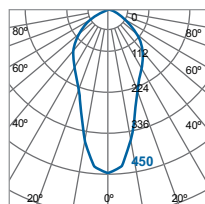

m	Lux	Ø cm
0.5	1800	32
1	450	63
1.5	200	95
2	113	126

Beam angle = 35°

LR3215.5-WFL

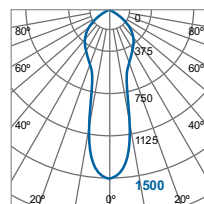

m	Lux	Ø cm
0.5	6000	32
1	1500	63
1.5	667	95
2	375	126

Beam angle = 35°

LR0920-25M25D

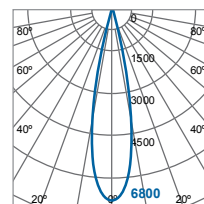

m	Lux	Ø cm
0.5	27200	22
1	6800	44
1.5	3022	67
2	1700	89

Beam angle = 25°

Dæmpbar lyskilder er markeret med dette symbol



R50
R63
R80



220-240V | Reflektor R50 / 63 / 80

Varenr.	Produktnavn	Type	Sokkel	Watt (W)	Lysstrøm (lm/cd)	Farve temp. (K)	Lysvinkel (°)	Levetid (timer)	Diameter (mm)	Længde (mm)	Vægt (g)	Dæmp	Energi mærke	Kolli	EAN kode / MM nummer
178313	LR2603.5-SWFL	1	E14	3.5	250/120	2800	90	15000	50	87	33	Nej	A+	10/60	4892657 040623
178314	LR2407.5-SWFL	2	E27	7.5	600/230	2800	90	15000	63	104	69	Nej	A+	10/60	4892657 041354
178312	LR1204DGv2-WFL	3	E14	4	220/200	2800	60	25000	50	76	40	Nej	A+	10/60	4892657 034080
178348	LR4307-SWFL	4	E27	7	520/230	2800	90	15000	78	112	90	Nej	A+	10/60	4892657 046861

LR2603.5-SWFL

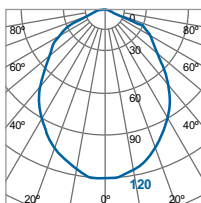

m	Lux	Ø cm
0.5	480	100
1	120	200
1.5	53	300
2	30	400

Beam angle = 90°

LR2407.5-SWFL

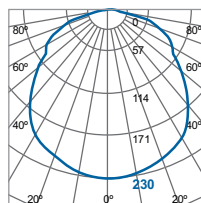

m	Lux	Ø cm
0.5	920	100
1	230	200
1.5	102	300
2	58	400

Beam angle = 90°

LR4307-SWFL

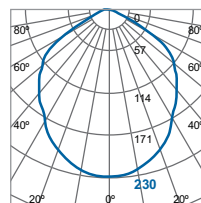

m	Lux	Ø cm
0.5	920	100
1	230	200
1.5	102	300
2	58	400

Beam angle = 90°



2



100% 10%
Dæmpes med lysdæmper

3



100% 10%
Dæmpes med lysdæmper

1



100% 10%
Dæmpes med lysdæmper

12V AC/DC / 220-240V | AR111 - Passer til traditionelle halogen transformere*

Varenr.	Produktnavn	Type	Sokkel	Watt (W)	Lysstrøm (lm/cd)	Farve temp. (K)	Lysvinkel (°)	Levetid (hrs)	Diameter (mm)	Længde (mm)	Vægt (g)	Dæmp	Kolli	EAN kode / MM nummer
178245	LR1715d-75H08D	1	GU10	15	950/20000	2800	8	40000	111	89	276	Ja	6/24	4892657 040050
178086	LR1615d-75H24D	1	GU10	15	950/5000	2800	24	40000	111	89	276	Ja	6/24	4892657 033397
178085	LR1815d-75H45D	1	GU10	15	950/2000	2800	45	40000	111	89	276	Ja	6/24	4892657 033465
178240	ER2115d-75H08D	2	G53	15	850/17000	2800	8	25000	111	62	275	Ja	6/24	4892657 037883
178241	ER2015d-75H24D	2	G53	15	950/5000	2800	24	25000	111	62	275	Ja	6/24	4892657 037906
178242	ER2215d-75H45D	2	G53	15	850/2000	2800	45	25000	111	62	275	Ja	6/24	4892657 037920
178275	ER2711d-50H24D	3	G53	11	600/3600	2800	24	35000	111	58	230	Ja	6/24	4892657 044478
178276	ER2211d-50H45D	3	G53	11	630/1400	2800	45	35000	111	62	266	Ja	6/24	4892657 044492

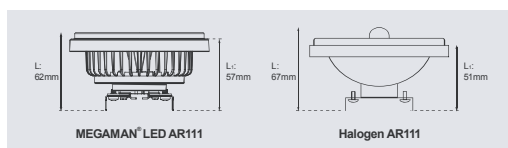

15W LED AR111 12V AC/DC Dæmpbar Traditionel 75W Halogen QR111 12V AC/DC

*Rekvirér vor transformertjekliste

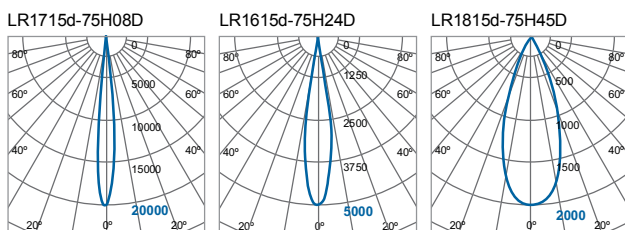

m	Lux	Ø cm
0.5	80000	7
1	20000	14
1.5	8889	21
2	5000	28
Beam angle = 8°		
m	Lux	Ø cm
0.5	20000	21
1	5000	43
1.5	222	64
2	1250	85
Beam angle = 24°		
m	Lux	Ø cm
0.5	8000	41
1	2000	83
1.5	889	124
2	500	166
Beam angle = 45°		

Dæmpbar lyskilder er markeret med dette symbol



GX53



2

1



220-240V | GX53 pærer

Varenr.	Produktnavn	Type	Sokkel	Watt (W)	Lysstrøm (lm)	Farve temp. (K)	Lysvinkel (°)	Levetid (timer)	Diameter (mm)	Længde (mm)	Vægt (g)	Dæmp	Energi mærke	Kolli	EAN kode / MM nummer
178311	LR2205	1	GX53	5	300	2800	90	15000	75	24	59	Nej	A+	10/60	4892657 038040
178315	LR2205d	1	GX53	5	300	2800	90	25000	75	24	59	Ja	A+	10/60	4892657 040142
178031	LR1305-60D	2	GX53	5	420	2800	60	30000	75	25	82	Nej	A+	10/60	4892657 029703
178035	LR1305-30D	2	GX53	5	420	2800	30	30000	75	25	82	Nej	A+	10/60	4892657 028751
178034	LR1304-VWFL	2	GX53	4	1055	2800	60	30000	75	25	82	Nej	A+	10/60	4892657 029277



3



4



4



5

□ Hvid □ Sølv

PLANEX | PALMLITE

Varenr.	Produktnavn	Type	Sokkel	Watt (W)	Farve	Dimensioner (mm)	Kolli	EAN kode / MM nummer
172650	PLANEX L0504RC - m/lyskilde	3	GX53	7	Hvid	H34 x Ø110/90	10/60	4892657 015065
172652	PLANEX L0504RC - m/lyskilde	3	GX53	7	Sølv	H34 x Ø110/90	10/60	4892657 015072
172651	PLANEX L0504RC - m/lyskilde	3	GX53	9	Hvid	H34 x Ø110/90	10/60	4892657 015058
172653	PLANEX L0504RC - m/lyskilde	3	GX53	9	Sølv	H34 x Ø110/90	10/60	4892657 015089
172368	PLANEX F02718RC - m/lyskilde	4	GX53	13	Hvid	H34 x Ø100/90	10/60	4892657 013405
172367	PLANEX F02718RC - m/lyskilde	4	GX53	13	Sølv	H34 x Ø100/90	10/60	4892657 015430
172654	PLANEX F02718RC - u/lyskilde	4	GX53	-	Hvid	H34 x Ø100/90	10/60	4892657 015430
172365	PLANEX F02718RC - m/lyskilde	4	GX53	7	Sølv	H34 x Ø100/90	10/60	4892657 013375
172267	PALMLITE Dekoring Sølv	-	-	-	-	H17 x Ø82	10/60	6435200 128591
172370	PALMLITE Løs fatning LA241	-	GX53	-	-	-	10/60	-
172266	PALMLITE Dekoring m/fatning	5	GX53	-	-	H17 x Ø82	10/60	4020856 721023

LR1305-30D

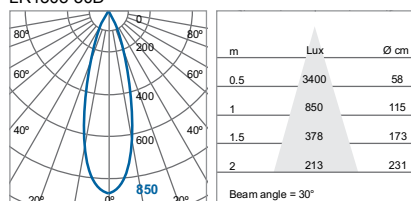

LR1305-60D

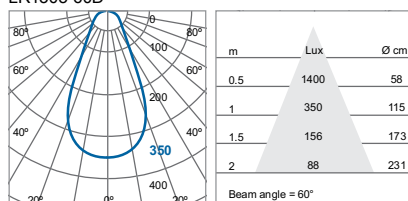

Dæmpbar lyskilder er markeret med dette symbol



NYHED
LED størrelse
= Halogen



220-240V | GU9 pære

Varenr.	Produktnavn	Type	Sokkel	Watt (W)	Lysstrøm (lm)	Farve temp. (K)	Levetid (timer)	Diameter (mm)	Længde (mm)	Vægt (g)	Dæmp	Energi mærke	Kolli	EAN kode / MM nummer
178350	LU0502.4	1	GU9	2.4	190	2800	15000	19	46	12	Nej	A++	20/120	4892657046687
178217	LU0104d	4	GU9	4	200	2800	25000	28	68	32	Ja	A+	20/120	4020856491124
178222	LU0303d	5	GU9	2	180	2800	25000	22	46	22	Ja	A+	20/120	4892657038293

12V AC/DC | G4 pære

Varenr.	Produktnavn	Type	Sokkel	Watt (W)	Lysstrøm (lm)	Farve temp. (K)	Levetid (timer)	Diameter (mm)	Længde (mm)	Vægt (g)	Dæmp	Energi mærke	Kolli	EAN kode / MM nummer
178511	EU0301.2	2	G4	1.2 *	100	2800	15000	9.5	30	-	Nej	A++	20/180	4892657061086
178216	EU0102	3	G4	2	420	3000	25000	19	45	11	Nej	A+	20/120	4892657035926

*Modsvarende 10W halogenstift i størrelse og effekt

220-240V | Natlampe

Varenr.	Produktnavn	Type	Sokkel	Watt (W)	Lysstrøm (lm)	Farve temp. (K)	Levetid (hrs)	Diameter (mm)	Længde (mm)	Vægt (g)	Dæmp	Energi mærke	Kolli	EAN kode / MM nummer
172270	NL010.2	6	2-pin	0.2	-	2700	50000	65	76	28	Nej	A+	20/120	4892657032277
172272	NL050.2	7	2-pin	0.2	-	2700	50000	41	66	25	Nej	A+	10/60	4892657014945

220-240V | Signallampe / parfumepære

Varenr.	Produktnavn	Type	Sokkel	Watt (W)	Lysstrøm (lm)	Farve temp. (K)	Lysvinkel (°)	Levetid (timer)	Diameter (mm)	Længde (mm)	Vægt (g)	Dæmp	Energi mærke	Kolli	EAN kode / MM nummer
178310	LG2402d	8	E14	2	100	2800	330	25000	26	57	17	Ja	A+	20/120	4892657038491

Dæmpbar lyskilde er markeret med dette symbol



CLUSTERLITE® R7s



220-240V | Clusterlite®

Varenr.	Produktnavn	Type	Sokkel	Watt (W)	Lysstrøm (lm)	Farve temp. (K)	Levetid (timer)	Diameter (mm)	Længde (mm)	Vægt (g)	Dæmp	Energi mærke	Kolli	EAN kode / MM nummer
● 574022	LH0127*	1	E27	27	2800	4000	25000	63	188	345	Nej	A+	6/24	4982657 045987
● 574023	LH0135*	1	E27	35	4160	4000	25000	63	188	345	Nej	A+	6/24	4020856 608249

* Med indbygget kølefunktion

220-240V | R7s pærer til arbejdslamper og armaturer

Varenr.	Produktnavn	Type	Sokkel	Watt (W)	Lysstrøm (lm)	Farve temp. (K)	Levetid (timer)	Dimensioner (mm)	Vægt (g)	Dæmp	Energi mærke	Kolli	EAN kode / MM nummer
● 178083	LJ0107	2	R7s	7	450	2800	25000	B56 x H30 x L83	115	Ja	A+	10/60	4020856 490028
● 178088	LJ0209	3	R7s	9	600	2800	25000	B56 x H29 x L118	144	Ja	A+	10/60	4982657 036756

LED Lysrør

- Lavet af glas der giver dem robust styrke, når lysrøret er opsat. Glasset er produceret med en plastik coating, der sikrer at glasskår ikke spredes ved evt. beskadigelse af lysrøret
- Fordelagtig erstatning for traditionelle T8 lysstofrør med glimtænder
- 330° lysspredning sikrer høj effektivitet i eksisterende reflektorer
- Tænder med det samme med 100% lysstyrke, selv med temperaturer ned til -30°C



Standard serie | 220-240V

Varenr.	Produkt navn	Type	Sokkel	Watt (W)	Lysstrøm (lm)	Farve temp. (K)	Levetid (timer)	Diameter (mm)	Længde (mm)	Vægt (g)	Energi mærke	Kolli	EAN kode / MM nummer	
178249	LT0414-840	330°	1	G13	14	1300	4000	40000	27.5	602	169	A+	1/12	4892657 043983
178250	LT0523.5-830	330°	1	G13	23.5	2200	3000	40000	27.5	1212	190	A+	1/12	4892657 043556
178247	LT0523.5-840	330°	1	G13	23.5	2400	4000	40000	27.5	1212	190	A+	1/12	4892657 043990
178248	LT0624.5-840	330°	1	G13	24.5	2600	4000	40000	27.5	1513	229	A+	1/12	4892657 043228

Professionel serie | 220-240V

Varenr.	Produkt navn	Type	Sokkel	Watt (W)	Lysstrøm (lm)	Farve temp. (K)	Levetid (timer)	Diameter (mm)	Længde (mm)	Vægt (g)	Energi mærke	Kolli	EAN kode / MM nummer	
178219	LT0132-830	330°	1	G13	32	2560	3000	50000	27.5	1212	398	A+	1/12	4892657 035001
178220	LT0242-830	330°	1	G13	42	3300	3000	50000	27.5	1513	415	A+	1/12	4892657 037128
178239	LT0132-840	330°	1	G13	32	2820	4000	50000	27.5	1212	398	A+	1/12	4892657 035353
178235	LT0242-840	330°	1	G13	42	3600	4000	50000	27.5	1513	415	A+	1/12	4892657 035988

Glimtænder | Tilbehør

Varenr.	Produkt navn
178299	Dummy Glimtænder



Armaturer til T8 LED rør - se side 59

Øvrigt LED



ØVRIGT LED



220-240V | Segula Deko LED

HØJ LUMEN + DÆMBAR

Varenr.	Produkt navn	Type	Sokkel	Watt (W)	Lysstrøm (lm)	Farve temp. (K)	Levetid (timer)	Diameter (mm)	Længde (mm)	Vægt (g)	Dæmp	Energi mærke	Kolli	EAN kode
177003	Edison Filament	1	E27	6	500	2200	20000	65	142	0.56	Ja	A+	10/60	4260150052960
177001	Candle Filament	2	E14	4	320	2200	20000	33	95	0.017	Ja	A+	10/60	4260150052533
177002	Classic Filament	3	E27	6	500	2200	20000	60	108	0.04	Ja	A+	10/60	4260150052786
177004	Globe Filament	4	E27	6	620	2200	20000	95	130	0.06	Ja	A+	10/60	4260150052830
177005	Globe Filament	5	E27	8	720	2200	20000	125	170	0.11	Ja	A+	10/60	4260150052861



6

220-240V | Signalpære LED

Varenr.	Produkt navn	Type	Sokkel	Watt (W)	Lysstrøm (lm)	Farve temp. (K)	Levetid (timer)	Diameter (mm)	Længde (mm)	Vægt (g)	Dæmp	Energi mærke	Kolli	EAN kode
169162	Signalpære LED	6	E14	1.4	110	2500	30000	25	58	0.014	Nej	A+	20/120	7319630000551



7

12V AC/DC | G4 LED, leveres i 2 stk. pakning

Varenr.	Produkt navn	Type	Sokkel	Watt (W)	Lysstrøm (lm)	Farve temp. (K)	Levetid (timer)	Diameter (mm)	Længde (mm)	Vægt (g)	Dæmp	Energi mærke	Kolli	EAN kode
171463	G4 LED med 9 dioder	7	G4	1.8	150	2800	20000	28	35	0.018	Nej	A+	20/200	5701761960262

Elsparepærer





1



2



1

220-240V | Reflektor

Varenr.	Produkt navn	Type	Sokkel	Watt (W)	Lysstrøm (lm)	Farve temp. (K)	Levetid (timer)	Diameter (mm)	Længde (mm)	Vægt (g)	Dæmp	Energi mærke	Kolli	EAN kode / MM nummer
172222	BR0707i	1	GU10	7	-	2700	15000	50	65	46	Nej	A	10/60	4020856 141227
172224	BR0711i	1	GU10	11	-	2700	15000	50	76	51	Nej	A	10/60	4020856 141425
172226	BR2911	1	GU10	11	-	2700	8000	50	74	57	Nej	B	10/60	4592567 029284

220-240V | GU9

Varenr.	Produkt navn	Type	Sokkel	Watt (W)	Lysstrøm (lm)	Farve temp. (K)	Levetid (timer)	Diameter (mm)	Længde (mm)	Vægt (g)	Dæmp	Energi mærke	Kolli	EAN kode / MM nummer
172160	4U107i	2	GU9	7	310	2700	15000	37	65	32	Nej	A	20/120	4892657 011449
172161	4U109i	2	GU9	9	440	2700	15000	37	75	38	Nej	A	20/120	4020856 490929

ELSPARE PÆRER



220-240V | Classic

Varenr.	Produktnavn	Type	Sokkel	Watt (W)	Lysstrøm (lm)	Farve temp. (K)	Levetid (timer)	Diameter (mm)	Længde (mm)	Vægt (g)	Dæmp	Energi mærke	Kolli	EAN kode / MM nummer
172113	GSU218i	1	E27	18	900	2700	15000	65	118	89	Nej	A	10/60	4892657011463
172461	GSU109	1	E27	9	405	2700	10000	60	113	79	Nej	A	10/60	4020856210091
172462	GSU111	1	E27	11	570	2700	10000	60	113	82	Nej	A	10/60	4020856210114
172070	GA805i	2	E14	5	200	2700	15000	45	84	41	Nej	A	10/60	4020856181025
172075	GA805i	2	E27	5	200	2700	15000	45	74	44	Nej	A	10/60	4020856051120
172071	GA807i	2	E14	7	286	2700	15000	45	84	41	Nej	A	10/60	4020856181124
172076	GA807i	2	E27	7	286	2700	15000	45	74	44	Nej	A	10/60	4020856191123
172112	GA913i	3	E27	13	663	2700	15000	55	102	57	Nej	A	10/60	4892657011456

220-240V | Kerte

Varenr.	Produktnavn	Type	Sokkel	Watt (W)	Lysstrøm (lm)	Farve temp. (K)	Levetid (timer)	Diameter (mm)	Længde (mm)	Vægt (g)	Dæmp	Energi mærke	Kolli	EAN kode / MM nummer
172151	CL707iCS/SE	4	E14	7	286	2700	15000	37	99	43	Nej	A	10/60	4020856940233
172154	CL709iCS/SE	4	E14	9	405	2700	15000	37	109	48	Nej	A	10/60	4020856119028
172463	CL405CS/SE	4	E14	5	180	2700	15000	37	99	43	Nej	A	10/60	4892657011579

220-240V | Softlight

Varenr.	Produktnavn	Type	Sokkel	Watt (W)	Lysstrøm (lm)	Farve temp. (K)	Levetid (timer)	Diameter (mm)	Længde (mm)	Vægt (g)	Dæmp	Energi mærke	Kolli	EAN kode / MM nummer
172050	CT0107i	5	E14	7	286	2700	15000	45	75	40	Nej	A	10/60	4020856040025
172051	CT0107i	5	E27	7	286	2700	15000	45	73	40	Nej	A	10/60	4020856040124
172052	CT0109i	5	E14	9	405	2700	15000	45	82	48	Nej	A	10/60	4020856041022
172053	CT0109i	5	E27	9	405	2700	15000	45	80	49	Nej	A	10/60	4020856041121
172054	CT0211i	5	E27	11	570	2700	15000	60	103	66	Nej	A	10/60	4020856045020
172055	CT0215i	5	E27	15	650	2700	15000	60	103	67	Nej	A	10/60	4020856046126
172056	CT0318i	5	E27	18	900	2700	15000	60	103	70	Nej	A	10/60	4892657011470

ELSPARE PÆRER



220-240V | Liliput plus

Varenr.	Produktnavn	Type	Sokkel	Watt (W)	Lysstrøm (lm)	Farve temp. (K)	Levetid (timer)	Diameter (mm)	Længde (mm)	Vægt (g)	Dæmp	Energi mærke	Kolli	EAN kode / MM nummer
172045	MU123i	1	E27	23	1500	2700	15000	45	120	80	Nej	A	10/60	4020856 333127
172046	MU130i	1	E27	30	2000	2700	15000	58	156	173	Nej	A	10/60	4892657 011487
172040	MU111i	2	E14	11	700	2700	15000	45	86	52	Nej	A	10/60	4020856 330027
172041	MU115i	2	E14	15	950	2700	15000	45	95	60	Nej	A	10/60	4020856 331024
172042	MU111i	2	E27	11	700	2700	15000	45	84	54	Nej	A	10/60	4020856 330126
172043	MU115i	3	E27	15	950	2700	15000	45	93	62	Nej	A	10/60	4020856 331123
172044	MU120i	3	E27	20	1300	2700	15000	45	112	75	Nej	A	10/60	4020856 332120

220-240V | Spiral

Varenr.	Produktnavn	Type	Sokkel	Watt (W)	Farve temp. (K)	Lysstrøm (lm)	Levetid (timer)	Diameter (mm)	Længde (mm)	Vægt (g)	Dæmp	Energi mærke	Kolli	EAN kode / MM nummer
172080	SP0205	5	E27	5	2700	300	10000	46	90	32	Nej	A+	10/60	4892657 018509
172081	SP0205	4	E14	5	2700	300	10000	46	92	32	Nej	A+	10/60	4892657 017342
172082	SP0208	5	E27	8	2700	500	10000	46	97	35	Nej	A	10/60	4892657 017267
172083	SP0208	4	E14	8	2700	500	10000	46	99	35	Nej	A	10/60	4892657 017250
172084	SP0211	5	E27	11	2700	700	10000	46	100	45	Nej	A	10/60	4892657 017298
172085	SP0211	4	E14	11	2700	700	10000	46	104	45	Nej	A	10/60	4892657 017281
172086	SP0214	5	E27	14	2700	900	10000	46	116	51	Nej	A	10/60	4892657 016475
172087	SP0214	4	E14	14	2700	900	10000	46	114	51	Nej	A	10/60	4892657 021677
172088	SP0220	5	E27	20	2700	1350	10000	46	134	76	Nej	A	10/60	4892657 016482
172089	SP0223	5	E27	23	2700	1550	10000	46	140	82	Nej	A	10/60	4892657 016499

ELSPARE PÆRER



220-240V | Clusterlite



Varenr.	Produktnavn	Type	Sokkel	Watt (W)	Lysstrøm (lm)	Farve temp. (K)	Levetid (timer)	Diameter (mm)	Længde (mm)	Vægt (g)	Dæmp	Energi mærke	Kolli	EAN kode / MM nummer
574001	HC01040i	2	E27	40	2680	2700	15000	63	166	257	Nej	A+	1/12	4020856607129
574003	HC01040i	2	E27	40	2680	3000	15000	63	166	257	Nej	A+	1/12	4020856607136
574004	HC01060i	2	E27	60	4000	2700	15000	63	188	315	Nej	B	1/12	4020856608126
574006	HC01100i	1	E40	100	6700	3000	15000	80	279	588	Nej	B	1/12	4892657013269
574016	HC01080i	1	E27	80	5400	2700	15000	80	224	553	Nej	B	1/12	4892657013214
574018	HC01100i	1	E27	100	6700	2700	15000	80	267	578	Nej	B	1/12	4892657011425

220-240V | Kompakt-rør

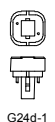
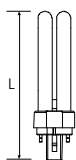
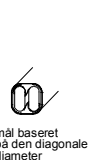

Varenr.	Produktnavn	Type	Sokkel	Watt (W)	Lysstrøm (lm)	Farve temp. (K)	Levetid (timer)	Diameter (mm)	Længde (mm)	Vægt (g)	Energi mærke	Kolli	EAN kode / MM nummer
176700	T4G24Q113	4	G24q1	13	900	2700	10000	41	133	44	A	10/60	4892657015294
176701	T4G24Q113	4	G24q1	13	900	3000	10000	41	133	44	A	10/60	4892657015713
176708	T4G24D110	4	G24d1	10	600	2700	10000	41	109	37	B	10/60	4020856235803
176709	T4G24D113	4	G24d1	13	900	2700	10000	41	139	42	A	10/60	4020856235810
176710	T4G24D218	4	G24d2	18	1200	2700	10000	41	149	51	B	10/60	4020856235827
176712	T4G24D110	4	G24d1	10	600	3000	10000	41	109	37	B	10/60	4892657015751
176714	T4G24D218	4	G24d2	18	1200	3000	10000	41	149	51	B	10/60	4892657015775
176715	T4G24D326	4	G24d3	26	1800	3000	10000	41	164	55	B	10/60	4892657015782
176716	T1G2305	3	G23	5	265	2700	10000	41	104	25	A	10/60	4020856235704
176717	T1G2307	3	G23	7	410	2700	10000	41	133	30	A	10/60	4020856235711
176718	T1G2309	3	G23	9	565	2700	10000	41	163	32	A	10/60	4020856235728
176719	T1G2311	3	G23	11	900	2700	10000	41	233	44	A	10/60	4020856235735
176704	T4G24Q218	3	G24q2	18	1200	3000	10000	41	143	51	A	10/60	4892657015720
176707	T4G24Q326	3	G24q3	26	1800	3000	10000	41	158	104	A	10/60	4892657015744
176740	TC-SL/E	5	2G11	18	1200	4000	12000	18	223	104	A	10/50	6435200188557
176741	TC-SL/E	5	2G11	24	1800	4000	12000	18	324	104	A	10/50	6435200167781
176742	TC-SL/E	5	2G11	36	2900	4000	12000	18	427	104	A	10/50	6435200188571
176743	TC-SL/E	5	2G11	18	1200	3000	12000	18	223	104	A	10/50	6435200167729
176744	TC-SL/E	5	2G11	24	1800	3000	12000	18	324	104	A	10/50	6435200167743
176745	TC-SL/E	5	2G11	36	2900	3000	12000	18	427	104	A	10/50	6435200167767

Halogen- og speciallys-kilder



VINTAGE PÆRER



220-240V | Vintage glødepærer

Varenr.	Produktnavn	Type	Sokkel	Watt (W)	Lysstrøm (lm)	Farve temp. (K)	Levetid (timer)	Diameter (mm)	Længde (mm)	Kolli	EAN kode
171348	Vintage Edison	1	E27	40	180	2300	1000	64	145	10/50	8421389982466
171349	Vintage Globe	2	E27	40	180	2300	1000	95	138	10/40	8421389982473
171350	Vintage Globe	3	E27	40	180	2300	1000	125	168	10	8421389983456

220-240V | Airam Vintage glødepærer

Varenr.	Produktnavn	Type	Sokkel	Watt (W)	Lysstrøm (lm)	Farve temp. (K)	Levetid (timer)	Diameter (mm)	Længde (mm)	Kolli	EAN kode
● 169462	Vintage Classic	4	E27	60	240	2300	3000	60	106	10/100	6435200194503
● 169461	Vintage Edison	5	E27	60	240	2300	3000	64	142	10/100	6435200194527
● 169464	Vintage Globe	6	E27	60	240	2300	3000	95	135	10/100	6435200194541
● 169463	Vintage Globe	7	E27	60	160	2300	3000	125	170	12	6435200194565

Obs: Små ridser fra produktionsprocessen kan forekomme på disse typer Vintagepærer, især Globe, og er således ikke et reklamationspunkt.

SPECIAL PÆRER



220-240V | Globepærer

Varenr.	Produktnavn	Type	Sokkel	Watt (W)	Lysstrøm (lm)	Farve temp. (K)	Levetid (timer)	Diameter (mm)	Længde (mm)	Kolli	EAN kode
171345	Globe *	2	E27	25	170	2700	1500	125	175	20	8421389550429
171346	Globe *	2	E27	40	350	2700	1500	125	175	20	8421389550436
171347	Globe *	2	E27	60	630	2700	1500	125	175	20	8421389550443

*Obs: Små ridser kan forekomme fra produktionsprocessen på disse typer Globepærer, og er således ikke et reklamationspunkt.

220-240V | Specialpærer

Varenr.	Produktnavn	Type	Sokkel	Watt (W)	Lysstrøm (lm)	Farve temp. (K)	Levetid (timer)	Diameter (mm)	Længde (mm)	Kolli	EAN kode
169183	Ovnpære / køleskabspære	4	E14	15	60	2700	1500	22	50	12	6435200001948
171184	Ovnpære	4	E14	25	120	2700	1000	23	50	50	5701761961740
171185	Ovnpære	9	E14	40	-	2700	1000	45	73	10/50	0043168350310
169788	Plantelampe	5	E27	60	-	2700	1500	122	135	10/100	6435206000170
169357	Topforspejlet	3	E27	60	500	2700	1000	60	107	10	6435200000385
169176	Rørpære	1	E14	25	120	2700	1000	20	115	25	6435200006745
169221	Flame	6	E14	3	-	2400	500	35	98	25	6435200010261

12V AC/DC | Halogen

Varenr.	Produktnavn	Type	Sokkel	Watt (W)	Lysstrøm (lm)	Farve temp. (K)	Levetid (timer)	Diameter (mm)	Længde (mm)	Kolli	EAN kode
169407	Halogen 2-pak	7	G4	10	100	2800	2000	8	33	10/100	6435200127495
169408	Halogen 2-pak	7	G4	20	255	2800	2000	8	33	10/100	6435200002730
169412	Halogen 2-pak	7	GY6.35	35	535	2800	2000	10	42	10/100	6435200135018
169413	Halogen 2-pak	7	GY6.35	50	840	2800	2000	10	42	10/100	6435200135032
169432	Halogen	8	GU4	20	145	2800	2000	35	34	10/100	6435200127518
169438	Halogen	8	GU5.3	20	460	2800	4000	50	34	10/60	6435200116246
169439	Halogen	8	GU5.3	35	730	2800	4000	50	34	10/60	6435200134721

E-SAVER HALOGEN



220-240V | E-saver GU10

Varenr.	Produktnavn	Type	Sokkel	Watt (W)	Lysstrøm (lm)	Lysvinkel (°)	Farve temp. (K)	Levetid (timer)	Diameter (mm)	Længde (mm)	Kolli	EAN kode
169449	E-saver-PAR16-36D	1	GU10	18	210	36	2800	2000	50	55	10/100	6435200144751
169450	E-saver-PAR16-36D	1	GU10	25	400	36	2800	2000	50	55	10/100	6435200144331
169451	E-saver-PAR16-36D	1	GU10	35	700	36	2800	2000	50	55	10/100	6435200144362
169452	E-saver-PAR16-36D	1	GU10	50	1200	36	2800	2000	50	55	10/100	6435200112828

220-240V | E-saver G9

Varenr.	Produktnavn	Type	Sokkel	Watt (W)	Lysstrøm (lm)	Farve temp. (K)	Levetid (timer)	Diameter (mm)	Længde (mm)	Kolli	EAN kode
169400	E-saver G9	2	G9	18	205	2800	2000	13	42	10/100	6435200143884
169470	E-saver G9	2	G9	28	370	2800	1000	13	42	10/100	6435200143914

220-240V | E-saver R7s

Varenr.	Produktnavn	Type	Sokkel	Watt (W)	Lysstrøm (lm)	Farve temp. (K)	Levetid (timer)	Diameter (mm)	Længde (mm)	Kolli	EAN kode
169415	E-saver-R7s	3	R7s	105	2000	2900	1000	8	78	10/100	6435200144034
169423	E-saver-R7s	3	R7s	105	2000	2900	1000	8	118	10/100	6435200144096
169425	E-saver-R7s	3	R7s	200	4000	2900	1000	10	118	10/100	6435200144157
169426	E-saver-R7s	3	R7s	350	7100	2900	1000	10	118	10/100	6435200144188

220-240V | E-saver R50/R63

Varenr.	Produktnavn	Type	Sokkel	Watt (W)	Lysvinkel (°)	Lysstrøm (lm)	Farve temp. (K)	Levetid (timer)	Diameter (mm)	Længde (mm)	Kolli	EAN kode
169471	E-saver-R50	4	E14	28	60	160	2800	2000	50	85	10/100	6435200143761
169478	E-saver-R63	4	E27	42	60	230	2800	2000	63	105	10/100	6435200143853

E-SAVER HALOGEN



220-240V | E-saver Classic

Varenr.	Produktnavn	Type	Sokkel	Watt (W)	Lysstrøm (lm)	Farve temp. (K)	Levetid (timer)	Diameter (mm)	Længde (mm)	Kolli	EAN kode
169475	E-saver-Krone	1	E14	30	410	2800	2000	45	78	10/100	6435200181688
169476	E-saver-Krone	1	E27	30	410	2800	2000	45	72	10/100	6435200181725
169481	E-saver-Krone	1	E14	20	240	2800	2000	45	78	10/100	6435200181015
169488	E-saver-Krone	1	E14	46	702	2800	2000	45	78	10/100	6435200181879
169489	E-saver-Krone	1	E27	20	240	2800	2000	45	72	10/100	6435200181039
169490	E-saver-Krone	1	E27	46	720	2800	2000	45	72	10/100	6435200181893
169472	E-saver-Classic	2	E27	30	410	2800	2000	55	98	10/100	6435200181428
169477	E-saver-Classic	2	E27	46	702	2800	2000	55	98	10/100	6435200181442
169479	E-saver-Classic	2	E27	20	240	2800	2000	55	98	10/100	6435200180933
169485	E-saver-Classic	2	E27	57	920	2800	2000	55	98	10/100	6435200181466
169486	E-saver-Classic	2	E27	77	1326	2800	2000	55	98	10/100	6435200181480
169487	E-saver-Classic	2	E27	116	2135	2800	2000	60	105	10/100	6435200181503

220-240V | E-saver Kerte

Varenr.	Produktnavn	Type	Sokkel	Watt (W)	Lysstrøm (lm)	Farve temp. (K)	Levetid (timer)	Diameter (mm)	Længde (mm)	Kolli	EAN kode
169474	E-saver-Kerte-klar	3	E14	30	410	2800	2000	35	100	10/100	6435200181602
169482	E-saver-Kerte-klar	3	E14	20	240	2800	2000	35	100	10/100	6435200180957
169483	E-saver-Kerte-snoet	4	E14	30	410	2800	2000	35	98	10/100	6435200181640
169231	E-saver-Kerte-vindstød	5	E14	20	240	2800	2000	35	124	10/100	6435200180995
169233	E-saver-Kerte-vindstød	5	E14	30	410	2800	2000	35	124	10/100	6435200181664

220-240V | Emhættepære

Varenr.	Produktnavn	Type	Sokkel	Watt (W)	Lysstrøm (lm)	Farve temp. (K)	Levetid (hrs)	Diameter (mm)	Længde (mm)	Kolli	EAN kode
169491	Emhættepære	6	E14	28	370	2800	2000	25	85	10/100	6435200192073

T8 / T5



2



3



1

220-240V | Lysstofrør T8

Varenr.	Produktnavn	Type	Sokkel	Watt (W)	Lysstrøm (lm)	Levetid (hrs)	Diameter (mm)	Længde (mm)	Energi mærke	Kolli	EAN kode
169701	Lysrør-830	2	G13	15	950	20000	26	438	B	25	6435200014184
169707	Lysrør-830	2	G13	18	1350	20000	26	590	A	25	6435200006653
169719	Lysrør-830	2	G13	36	3350	20000	26	1200	A	25	6435200006660
169725	Lysrør-830	2	G13	58	5250	20000	26	1500	A	25	6435200006677
169727	Lysrør-840	2	G13	18	1350	20000	26	590	A	25	6435200006714
169720	Lysrør-840	2	G13	36	3350	20000	26	1200	A	25	6435200006721
169726	Lysrør-840	2	G13	58	5250	20000	26	1500	A	25	6435200006738
169794	Glimtænder serieforb.	3	-	4-22	-	-	21	39	-	25/250	6435200003805
169795	Glimtænder Singel lys, løs	3	-	4-80	-	-	21	39	-	10/60	6435200116123
169796	Glimtænder Singel lys, 2-pak	3	-	4-65	-	-	21	39	-	25/250	6435200112507

220-240V | Lysstofrør T5

Varenr.	Produktnavn	Type	Sokkel	Watt (W)	Lysstrøm (lm)	Levetid (hrs)	Diameter (mm)	Længde (mm)	Energi mærke	Kolli	EAN kode
169784	Lysrør-HE*-830	1	G5	14	1350	24000	16	549	A+	25	6435200112118
169785	Lysrør-HE*-830	1	G5	21	2100	24000	16	849	A+	25	6435200112125
169786	Lysrør-HO*-830	1	G5	24	2000	24000	16	549	A+	25	6435200157270
169787	Lysrør-HE*-830	1	G5	28	2900	24000	16	1149	A+	25	6435200112132
169780	Lysrør-HE*-830	1	G5	35	2600	24000	16	1449	A+	25	6435200112149
169789	Lysrør-HO*-830	1	G5	39	3500	24000	16	849	A+	25	6435200157317
169790	Lysrør-HO*-830	1	G5	49	4900	24000	16	1449	A+	25	6435200115140
169791	Lysrør-HO*-830	1	G5	54	5400	24000	16	1149	A+	25	6435200151063
169792	Lysrør-HO*-830	1	G5	80	7000	24000	16	1149	A+	25	6435200166425
169777	Lysrør-HE*-840	1	G5	14	1350	24000	16	549	A+	25	6435200112156
169779	Lysrør-HE*-840	1	G5	21	2100	24000	16	849	A+	25	6435200112163
169793	Lysrør-HO*-840	1	G5	24	2000	24000	16	549	A+	25	6435200157294
169778	Lysrør-HE*-840	1	G5	28	2900	24000	16	1149	A+	25	6435200112170
169781	Lysrør-HE*-840	1	G5	35	3600	24000	16	1449	A+	25	6435200112187
169797	Lysrør-HO*-840	1	G5	39	3500	24000	16	849	A+	25	6435200157331
169782	Lysrør-HO*-840	1	G5	49	4900	24000	16	1449	A+	25	6435200115157
169783	Lysrør-HO*-840	1	G5	54	5400	24000	16	1149	A+	25	6435200151087
169798	Lysrør-HO*-840	1	G5	80	7000	24000	16	1149	A+	25	6435200157256

*Type HE = High Efficiency
HO = High Output

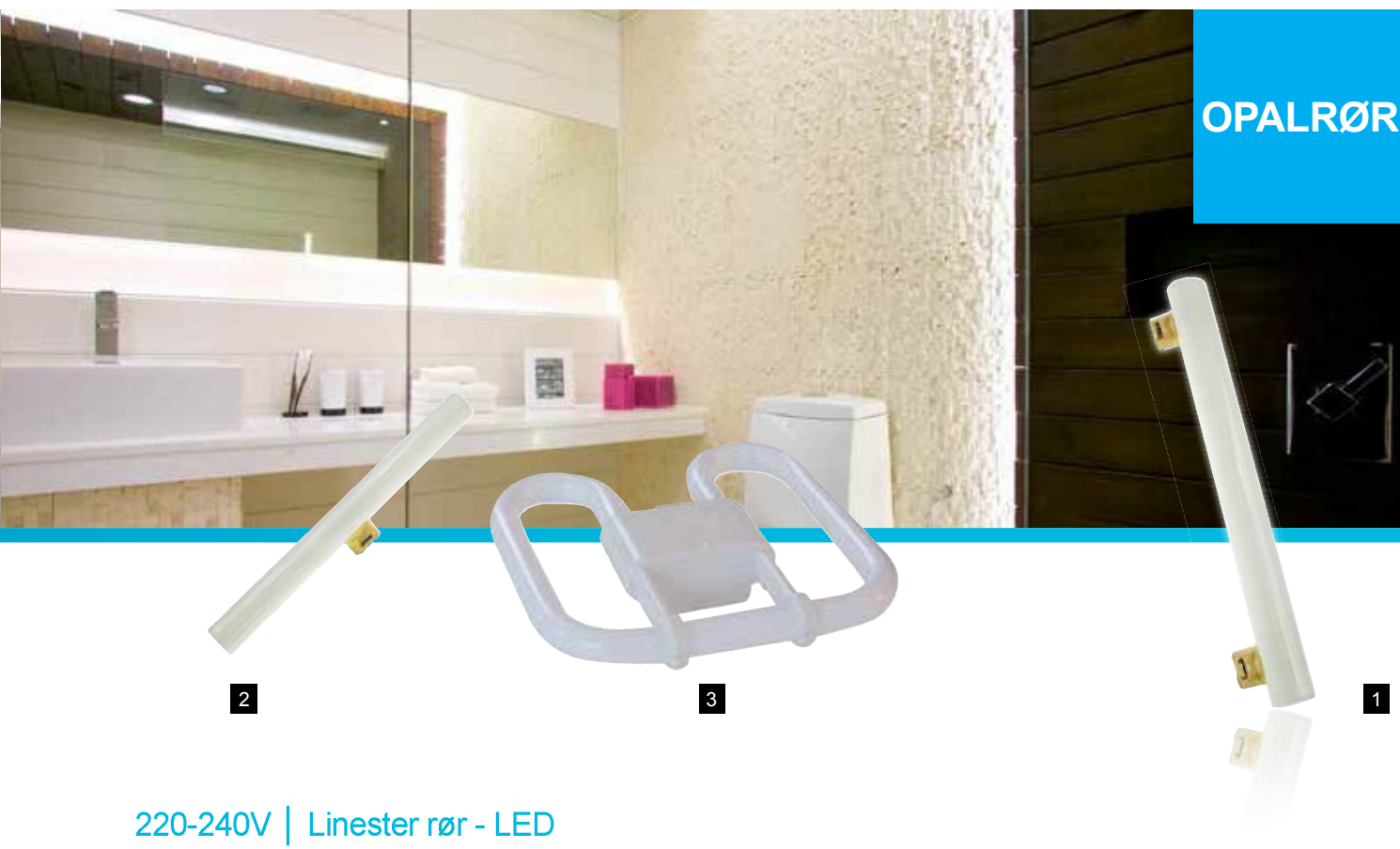

220-240V | Linester rør - LED

Varenr.	Produkt navn	Type	Sokkel	Watt (W)	Lysstrøm (lm)	Farve temp. (K)	Levetid (hrs)	Diameter (mm)	Længde (mm)	Dæmp	Energi mærke	Kolli	EAN kode
169316	Opalrør-2pind	1	s14s	4	300	2700	20000	30	300	Nej	A+	10/100	8421389983920
169317	Opalrør-2pind	1	s14s	6	500	2700	20000	30	500	Nej	A+	10/100	8421389983944
169314	Opalrør-1pind	2	s14d	4	300	2700	20000	30	300	Nej	A+	10/100	8421389983913
169315	Opalrør-1pind	2	s14d	6	500	2700	20000	30	500	Nej	A+	10/100	8421389983937

220-240V | Kompaktrør

Varenr.	Produkt navn	Type	Sokkel	Watt (W)	Lysstrøm (lm)	Levetid (hrs)	Diameter (mm)	Længde (mm)	Dæmp	Energi mærke	Kolli	EAN kode
169630	Kompaktrør-2stav-830	3	2D2-GR8	16	1050	10000	135	135	Nej	A	10	6435200009074
169631	Kompaktrør-2stav-827	3	2D2-GR8	28	2250	10000	199	199	Nej	A	10	6435200009111
169632	Kompaktrør-4stav-830	3	2D4-GR10	16	1050	10000	135	135	Nej	A	10	6435200009081
169633	Kompaktrør-4stav-830	3	2D4-GR10	28	2250	10000	199	199	Nej	A	10	6435200009098
169634	Kompaktrør-4stav-830	3	2D4-GR10	38	2800	10000	199	199	Nej	A	10	6435200009104

METAL HALOGEN



220-240V | Metalhalogen

Varenr.	Produktnavn	Type	Sokkel	Watt (W)	Lysstrøm (lm)	Farve temp. (K)	Levetid lodret montering (timer)	Levetid vandret montering (timer)	Diameter (mm)	Længde (mm)	Kolli	EAN kode
574040	Metalhalogen	1	G12	35	3400	3000	15000	15000	15	100	10	6435200178343
574041	Metalhalogen	1	G12	70	6200	3000	15000	15000	19	102	10	6435200178350
574046	Metalhalogen	2	G8.5	35	3400	3000	15000	15000	15	85	10	6435200178411
574047	Metalhalogen	2	G8.5	70	6200	3000	12000	12000	15	85	10	6435200178428
574044	Metalhalogen	3	R7s	35	3400	3000	10000	10000	21	118	12	6410048846272
574042	Metalhalogen	3	R7s	70	6200	3000	15000	15000	20	118	10	6435200178459
574045	Metalhalogen	3	R7s	150	14000	3000	15000	15000	24	135	10	6435200178466
574043	Metalhalogen	4	E27	70	6600	3000	20000	20000	48	209	12	5701761960224
574052	Metalhalogen	4	E40	100	9200	3000	10000	15000	48	209	12	0043168924788
574053	Metalhalogen	4	E40	150	14000	3000	15000	20000	48	209	12	0043168387491
574054	Metalhalogen	4	E40	250	25000	3000	24000	24000	48	260	12	0043168105897
574055	Metalhalogen	4	E40	400	41000	3000	20000	20000	60	278	12	0043168130677

Butiksbelysning



NYHED:

PERFEKT WHITE TEKNOLOGI

Megaman introducerer et helt nyt lyskoncept til butiksbelysning som hedder "Perfekt White".

Denne teknologi er speciel velegnet til alle tøj- og skobutikker, da lysteknologien fremhæver den hvide farve helt exceptionelt og f.eks ved tøj hvor der er anvendt blegemiddel i fremstillingsprocessen af tekstilet, vil dette fremstå med en exceptionel klar kontrast og intens skarpt hvid farve i forhold til almindelig butiksbelysning.

Perfekt White teknologien kan bestilles for nye LED integrerede armaturer som Vito, Carlo, Modena samt lyskilder som AR111.

MODENA LED 3-fase skinnerpot

35W Metal halogen Erstatning



70W Metal halogen Erstatning



F28049TK

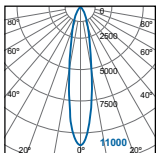

m	Lux	Ø cm
0.5	44000	22
1	11000	44
1.5	4889	67
2	2750	89

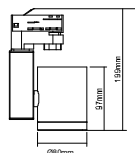

F25349TK

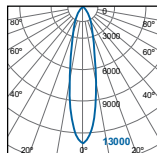

m	Lux	Ø cm
0.5	52000	22
1	13000	44
1.5	5778	67
2	3250	89

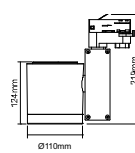

Lagervare

Bestillingsvare



Varenr.	Produkt navn	System Wattage (W)	Farve temp. (K)	Lumen (lm)	Lysvinkel (°)	Levetid (timer)	Dimension (mm)	EAN kode
574137	F28049TK	27	4000	2400	45	50000	Ø80 x L97 x H199	4892657043037
574135	F25349TK	50	4000	4500	45	50000	Ø110 x L124 x H219	4892657044409

* 25° er bestillingsvare for begge armaturer.

- Designet med kraftfuld lys- og lumenpakke på 90 lm/w med kun 50w energi forbrug.
- Standard 45 graders lysvinkel, men option for 25 graders lysvinkel
- Lagerføres i 4000 kelvin med kan også tilbydes/bestilles i 3000 kelvin
- Armaturene har et fleksibel justerbar ophæng med 355 gr. horisontal drejning og 90 gr vertikal drejning.
- Designet med aluminium præcisionsreflektor og forsatsglas incl. anti-blænding funktion
- Option for dæmpningsfunktion og Perfekt White teknologi

LED 3-fase skinnerpot

LOFT - L0601TK - PAR38



Se lyskilder på side 17



MOSAIC - F11517TK - PAR16



Se lyskilder på side 15



TOBY - F13117TK - AR111



Se lyskilder på side 19



Varenr.	Produktnavn	Farve	Dimension (mm)	EAN kode
574104	LOFT L0601TK - E27	Sølv	Ø110 x L124 x H219	4020856782307
574112	LOFT L0601TK - E27	Sort	Ø110 x L124 x H219	4020856782109
574102	MOSAIC F11517TK - GU10	Sølv	Ø58 x L77 x H215	4892657023008
574138	MOSAIC F11517TK - GU10	Hvid	Ø58 x L77 x H215	6435200176912
574139	MOSAIC F11517TK - GU10	Sort	Ø58 x L77 x H215	6435200176936
574103	TOBY F13117TK - GU10	Sølv	Ø117 x L--- x H220	4892657026481
574116	TOBY F13117TK - GU10	Hvid	Ø117 x L--- x H220	4892657026474
574117	TOBY F13117TK - GU10	Sort	Ø117 x L--- x H220	4892657026498

SKINNE SYSTEM



3-fase skinnesystem

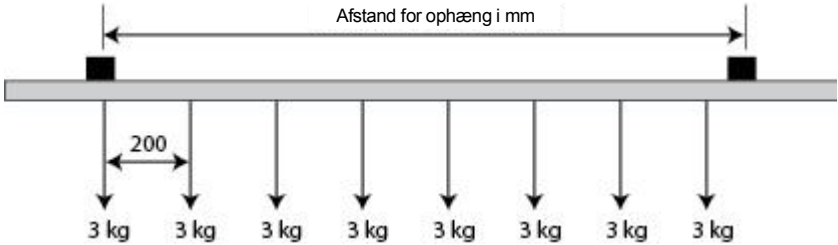
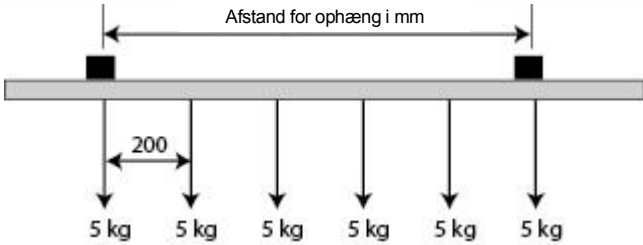
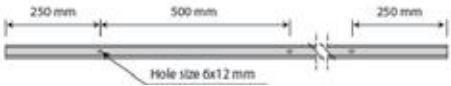
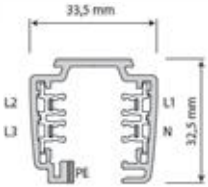
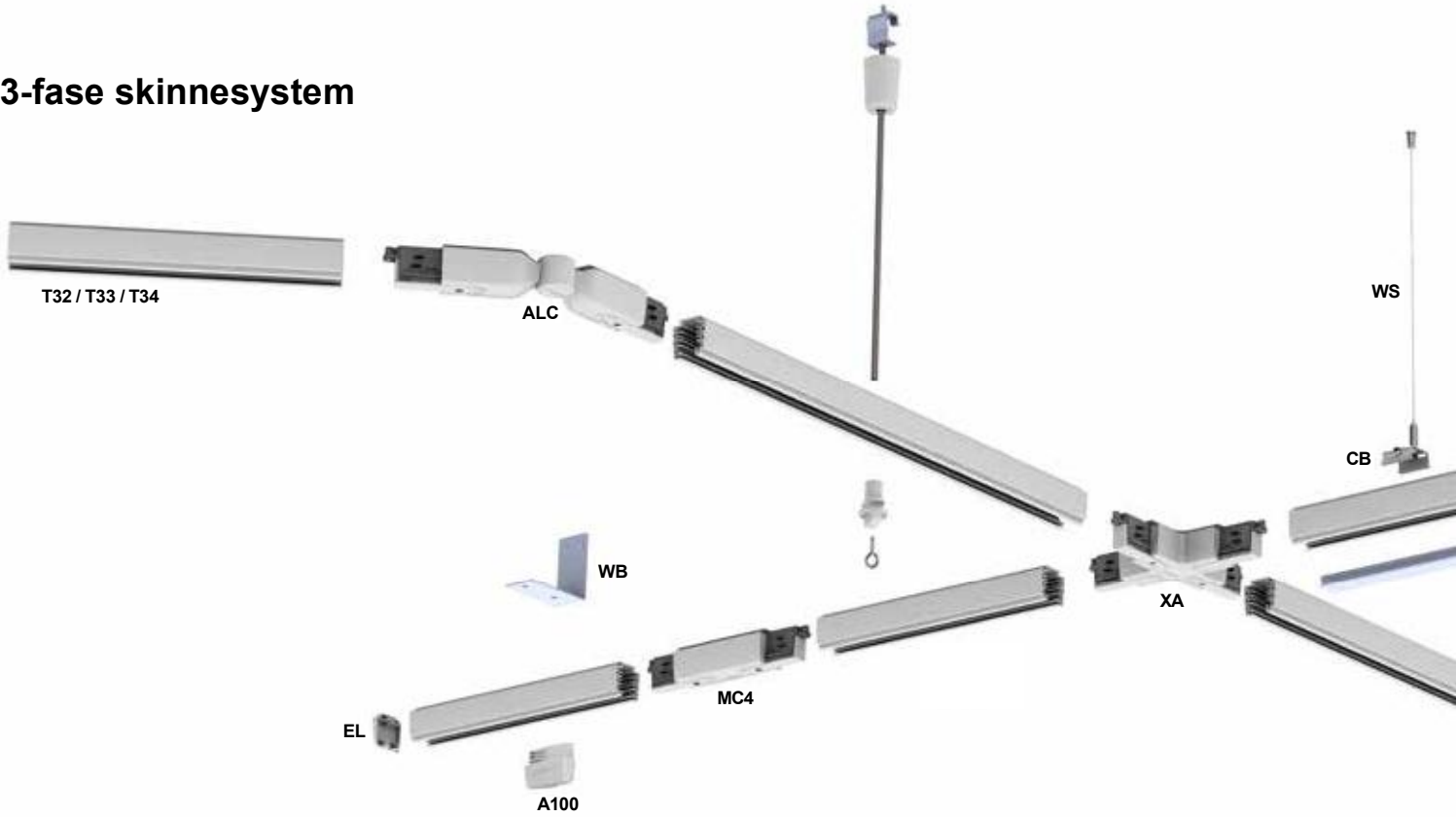

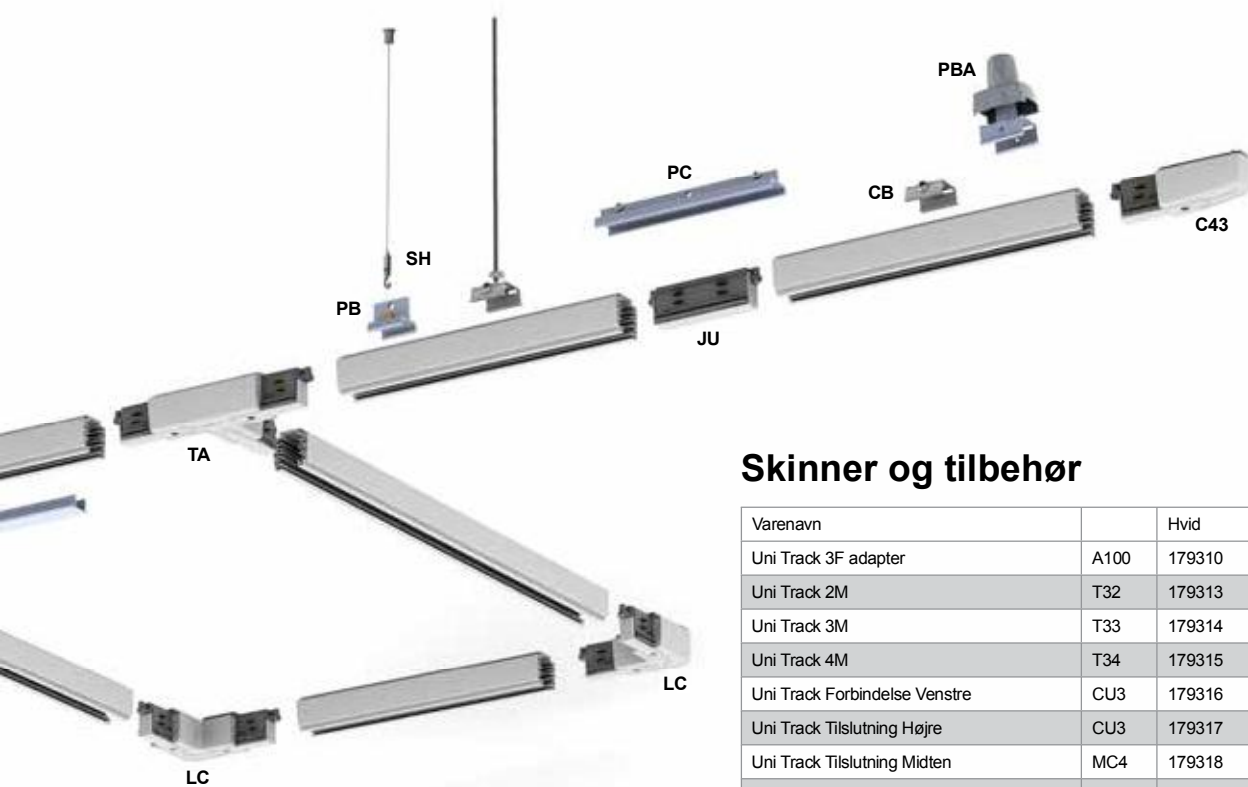

Skinner og tilbehør

Varenavn		Hvid	Sort	Grå
Uni Track 3F adapter	A100	179310	179311	179312
Uni Track 2M	T32	179313	179344	179329
Uni Track 3M	T33	179314	179345	179330
Uni Track 4M	T34	179315	179346	179331
Uni Track Forbindelse Venstre	CU3	179316	179347	179332
Uni Track Tilslutning Højre	CU3	179317	179348	179333
Uni Track Tilslutning Midten	MC4	179318	179349	179334
Uni Track L-hjørne Hvid	LC	179319	179350	179335
Uni Track Justerbar L-hjørne	ALC	179320	179351	179336
Uni Track T-stykke Venstre	TA3A	179321	179352	179337
Uni Track T-stykke Højre	TA3B	179322	179353	179338
Uni Track T-stykke Venstre	TA3C	179323	179354	179339
Uni Track T-stykke Højre	TA3D	179324	179355	179340
Uni Track X-delt	XA	179325	179356	179341
Uni Track Ende Dækplade	EC	179326	179357	179342
Uni Track Mellemstykke	JU	179328	179328	179328
Uni Track Loft / Wire Beslag	CB	179359	179361	179360
Uni Track Wire beslag	PB	179362	179364	179363
Uni Track Wireophæng Set 1,5M AJUST	WS15	179365	179365	179365
Uni Track Wireophæng Set 4,0M AJUST	WS40	179366	179366	179366
Uni Track Wire kobler Hvid	PC	179367	179369	179368
Uni Track Ophængningskrog	SH	179370	179370	179370
Uni track loftbeslag til T-Byg G	CB	179371	179372	179373

*Obs! Alle skinne produkter er bestillingsvarer, som normalt leveres med 1-3 dages leveringstid.

CARLO / VITO LED indbygningsspot

- Høj lys- og lumen pakke; 3600lm ved 3000 kelvin og 3800 lm ved 4000 kelvin
- Fleksibel 45 graders vippe vinkel og 355 graders rotationsfunktion
- Ekstern driver påkrævet
- Option for dæmpningsfunktion og Perfekt White teknologi.
- Mulighed for lineær dæmpning med DALI DSI eller 1-10v enhed.

CARLO - F28249RC 36W spot 50W Metal halogen erstatning

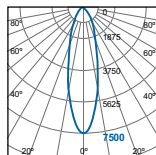

m	Lux	Ø cm
0.5	30000	32
1	7500	63
1.5	3333	95
2	1875	126

Beam angle = 35°

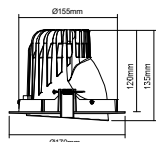

VITO - F29349RC 45W spot 70W Metal halogen erstatning

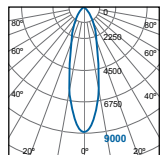
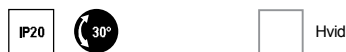

m	Lux	Ø cm
0.5	36000	32
1	9000	63
1.5	4000	95
2	2250	126

Beam angle = 35°

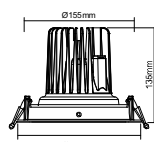

LED driver

Varenr.	Produkt
574077	Driver 1-10V til 574200
574078	Driver uden dæmp til 574200
574079	Driver 1-10V til 574201
574081	Driver uden dæmp til 574201

Varenr.	Produktnavn	Watt (W)	Lumen (lm)	Dimension (mm)	Hul diameter (mm)	Lysvinkel (°)	Farve temp. (K)	Levetid (timer)	Dæmpbar	EAN kode
574200	F28249RC	36	3600	Ø170 × H135	155	35/60	3000	50000	Ja*	4892657048650
574201	F29349RC	45	4100	Ø170 × H135	155	35/60	3000	50000	Ja	4892657047004

* Kan dæmpes med DALI, DSI eller 1-10V dæmpbar LED driver.

KARA LED indbygningsspot

35W Metal halogen erstatning



F51800RC



70W Metal halogen erstatning



F51700RC

Justérbar LED Floodlight til indbygning

- Justérbar vippefunktion af lampeenhed
- Kan anvendes til loft eller væg
- Ekstern driver er påkrævet

LED driver

Varenr.	Produkt
574075	Driver uden dæmp til 574202
574076	Driver uden dæmp til 574203

Varenr.	Produktnavn	Watt (W)	Lumen (lm)	Dimension (mm)	Lysvinkel (°)	Farve temp. (K)	Levetid (timer)	Hul diameter (mm)	EAN kode
574202	F51700RC	50	4100	L230 x B145 x H105	100	3000	25000	L220 x B130	4892657056624
574203	F51800RC	26	2200	L230 x B145 x H105	100	3000	25000	L220 x B130	4892657056631

CONXENTO indbygningsspot

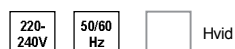

Varenr.	Produktnavn	Type	Sokkel	Dimension (mm)	Hul diameter (mm)	EAN kode
574105	F12501RC PAR20	1	E27	H174 x Ø107	95	4892657020557
574106	F12217RC AR111	2	GU10	H137 x Ø164	145	4892657020472
574108	F12101RC PAR30	3	E27	H180 x Ø142	125	4892657020434
574109	F12301RC PAR30	4	E27	H177 x Ø142	125	4892657020519

* Leveres uden lyskilder.



BERTO LED lyspanel

- Energibesparende LED paneler med helt op til 109 lm/w.
- Kan erstatte direkte 3x18w og 3x24w HE T5 modul armaturer
- Ultra tyndt design
- Anti-Glare funktion
- Option for dæmpning
- Ekstern driver påkrævet

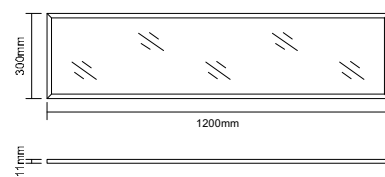
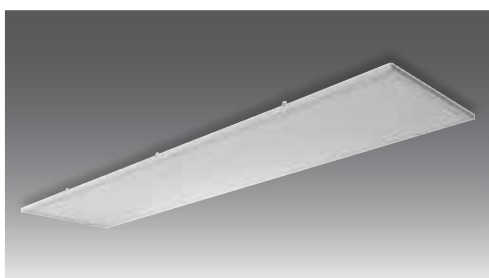
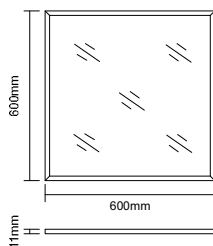

Tilbehør



Varenr. 574124 - LA10012
Wire-ophængskit



Varenr. 574123 - LA10013
Monteringsæt til overflade montering

IP20 Class III Hvid

Varenr.	Produktnavn	Watt (W)	Lumen (lm)	Dimension (mm)	Lysvinkel (°)	Farve temp. (K)	Levetid (timer)	EAN kode
574120	F31300RC	28	2700	B595 x L595 x H11	120	3000	50000	4892657041255
574122	F31500RC	43	4300	B595 x L595 x H11	120	3000	50000	4892657040821
574121	F31600RC	33	3600	B595 x L1195 x H11	120	3000	50000	4892657041286
574127	F31700RC	51	4500	B595 x L1195 x H11	120	3000	50000	4892657041316

* Kan dæmpes med DALI, DSI eller 1-10V dæmpbar LED driver.

LED driver - dæmpbar

Varenr.	Panel effekt
574092	28W
574093	33W
574094	43W
574095	51W

LED driver - ej dæmpbar

Varenr.	Panel effekt
574096	28W
574097	33W
574098	43W
574099	51W



F26400RC-d



60° IP20 Class I

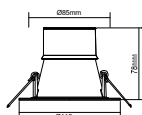
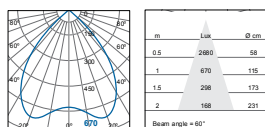

F26000RC



90° IP20 Class I

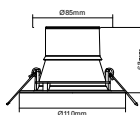
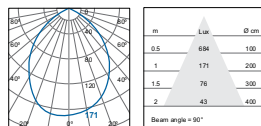

F26200RC



90° IP20 Class I

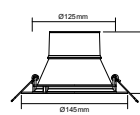
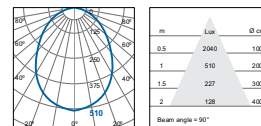

F26300RC



90° IP20 Class I

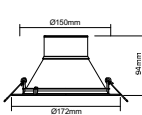
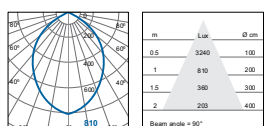

F27100RC



90° IP20 Class I High Output (F27100RC)

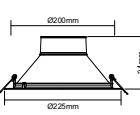
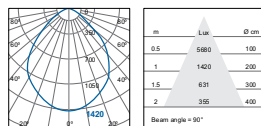

LED indbygningsspot 230V direkte tilslutning

- Integreret LED
- Aluminium
- Samleboks med sløjfemulighed for 3 x 1,5 mm²
- Opalfarvet diffuser
- Nem installation
- Høj effektivitet

220-240V 50/60 Hz Hvid

Varenr.	Produkt navn	Watt (W)	Lumen (lm)	Dimension (mm)	Hul diameter (mm)	Lysvinkel (°)	Farve temp. (K)	Levetid (timer)	Dæmpbar	EAN kode
573555	F26400RC-d	13	900	Ø110 x H78	85	60	2800	25000	Ja	4892657044652
573550	F26000RC	5	350	Ø110 x H68	85	90	2800	25000	Nej	4892657044614
573551	F26200RC	12.5	950	Ø145 x H84	125	90	2800	25000	Nej	4892657044621
573552	F26300RC	20.5	1560	Ø172 x H94	150	90	2800	25000	Nej	4892657044638
573553	F27100RC	35.5	2700	Ø225 x H94	200	90	2800	25000	Nej	4892657044645



F27500RC



90° IP44 Class III

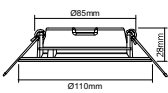
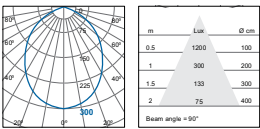

F27600RC



90° 30° IP20 Class II

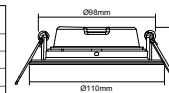
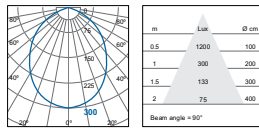

F29700RC



90° IP44 Class III

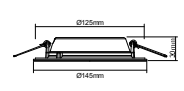
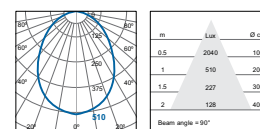

F29800RC



90° IP44 Class III

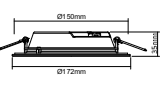
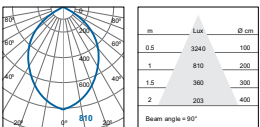

F29900RCv1



90° IP44 Class III

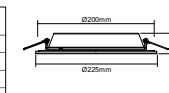
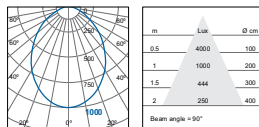

LED indbygningsspot - ekstern driver

- Integreret LED
- Ekstra lav indbygningshøjde
- Ekstern driver påkrævet

LED driver

Varenr.	Produkt
574070	Driver 1-10V til 573554
574071	Driver 1-10V til 573556
574072	Driver 1-10V til 573557
574073	Driver 1-10V til 573558
574074	Driver 1-10V til 573559

220-240V 50/60 Hz Hvid

Varenr.	Produktnavn	Watt (W)	Lumen (lm)	Dimension (mm)	Hul diameter (mm)	Lysvinkel (°)	Farve temp. (K)	Levetid (timer)	Dæmpbar	Anbefalet Driver	EAN kode
573554	F27600RC (justébar) IP20	7	550	Ø110 x H30	85	90	2800	25000	Ja	LD0208x1d-C350	489265704423
573556	F27500RC IP44	7	550	Ø110 x H28	85	90	2800	25000	Ja	LD0208x1d-C350	4892657046014
573557	F29700RC IP44	12	950	Ø145 x H30	125	90	2800	25000	Ja	LD0212x1-C350	4892657055320
573558	F29800RC IP44	19	1560	Ø172 x H35	150	90	2800	25000	Ja	LD0219x1-C500	4892657055351
573559	F29900RCv1 IP44	25	2000	Ø225 x H38	200	90	2800	25000	Ja	LD0425x1-C700	4892657055382

SIRA LED indbygningsspot til GU10 pære, 230V

F52517RC (Justérbar)



*Se lyskilder på side 15



- Kvalitets indbygningsspot med lav indbygningshøjde
- Udskiftelig GU10 lyskilde (leveres uden lyskilde)
- Justérbar 25°
- Sløjfemulighed for 3 x 1,5q
- Udført i metal
- Må installeres direkte mod isolering og dampspærre

Varenr.	Produkt navn	Sokkel	Max Watt (W)	Dimension (mm)	Hul diameter (mm)	EAN kode
573573	F52517RC-WH - hvid	GU10	7	Ø88 x H68	80	4892657057355
573572	F52517RC-SV - stål	GU10	7	Ø88 x H68	80	4892657057362

VERSA LED brandsikret armatur med integreret LED, 230V

- Designet til at yde beskyttelse af gulvet ovenfor i tilfælde af brand i 90 minutter
- Sløjfefunktion for 3 x 1,5 mm² gør installationen enkel
- Justérbar
- Fuldt kompatibelt til certifikat BS476 DEL 21
- Må installeres direkte mod isolering og dampspærre

F28951RC (Justérbar)

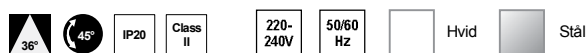
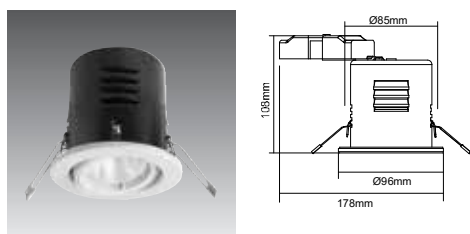

Varenr.	Produkt navn	Watt (W)	Lumen (lm)	Dimension (mm)	Hul diameter (mm)	Maks Lumen udbytte	Lysvinkel (°)	Farve temp. (K)	Levetid (timer)	Dæmpbar	EAN kode
573576	F28951RC - hvid IP20	8	600	Ø96 x L178 x H108	85	850	36	2800	30000	Ja	4892657050790
573577	F28951RC- stål IP20	8	600	Ø96 x L178 x H108	85	850	36	2800	30000	Ja	4892657050813



LED Indbyggningsarmatur



IP20 Klasse I Hvid

Varenr.	Produktnavn	Watt (W)	Lumen (lm)	Dimension (mm)	Lysvinkel (°)	Farve temp. (K)	Levetid (timer)	Dæmpbar	EAN kode
569100	D2PRIA	38	2600	L596 x B596 x H111	120	3000	50000	Nej	6435200199546
569101	D2PRIA - DIM*	38	2600	L596 x B596 x H111	120	3000	50000	DIM1-10V	N/A
569102	D2PRIA - DALI*	38	2600	L596 x B596 x H111	120	3000	50000	DALI	N/A
569103	D2PRIC	56	3400	L596 x B596 x H111	120	3000	50000	Nej	6435200200709
569104	D2PRIC - DIM*	56	3400	L596 x B596 x H111	120	3000	50000	DIM1-10V	N/A
569105	D2PRIC - DALI*	56	3400	L596 x B596 x H111	120	3000	50000	DALI	N/A

* DIM 1-10V / DALI er bestillingsvare til projekter

PROFI INL Armatur

- Indbygget LED, som giver indirekte lys
- Lyddæmpningsmulighed med 1-10V / DALI
- Stilfuldt og energibesparende All-round armatur, der kan bruges i kontorer, gangområder, skoler, institutioner og hospitaler m.v.
- Leveres som standard med driver uden dæmp (569100 + 569103)

PROFI ISS Armatur

- Indbygget LED, som giver indirekte lys
- Lyddæmpningsmulighed med 1-10V / DALI
- Stilfuldt og energibesparende All-round armatur, der kan bruges i kontorer, gangområder, skoler, institutioner og hospitaler m.v.
- Leveres som standard med driver uden dæmp (569106 + 569109)



IP20 Klasse I Hvid

Varenr.	Produktnavn	Watt (W)	Lumen (lm)	Dimension (mm)	Lysvinkel (°)	Farve temp. (K)	Levetid (timer)	Dæmpbar	EAN kode
569106	D2PRSA	36	3200	L596 x B596 x H60	90	3000	50000	Nej	6435200199621
569107	D2PRSA - DIM*	36	3200	L596 x B596 x H60	90	3000	50000	DIM1-10V	N/A
569108	D2PRSA - DALI*	36	3200	L596 x B596 x H60	90	3000	50000	DALI	N/A
569109	D2PRSM	42	3600	L596 x B596 x H60	90	3000	50000	Nej	6435200199669
569110	D2PRSM - DIM*	42	3600	L596 x B596 x H60	90	3000	50000	DIM1-10V	N/A
569111	D2PRSM - DALI*	42	3600	L596 x B596 x H60	90	3000	50000	DALI	N/A

* DIM 1-10V / DALI er bestillingsvare til projekter

LED Påbygningsarmatur

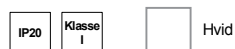
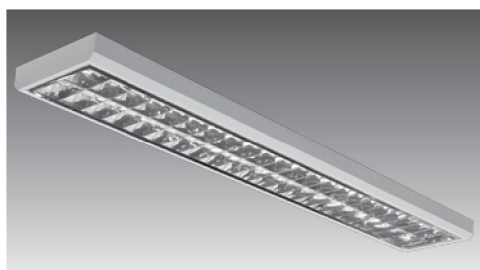

Varenr.	Produktnavn	Watt (W)	Lumen (lm)	Dimension (mm)	Lysvinkel (°)	Farve temp. (K)	Levetid (timer)	Dæmpbar	EAN kode
● 569112	D2PRAA	21	1700	L1210 x B238 x H65	120	3000	50000	Nej	6435200199836
● 569113	D2PRAA - DIM	21	1700	L1210 x B238 x H65	120	3000	50000	DIM1-10V	N/A
● 569114	D2PRAA - DALI	21	1700	L1210 x B238 x H65	120	3000	50000	DALI	N/A
● 569115	D2PRCA	40	3400	L1210 x B238 x H65	120	3000	50000	Nej	6435200199850
● 569116	D2PRCA - DIM	40	3400	L1210 x B238 x H65	120	3000	50000	DIM1-10V	N/A
● 569117	D2PRCA - DALI	40	3400	L1210 x B238 x H65	120	3000	50000	DALI	N/A

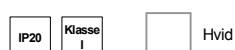
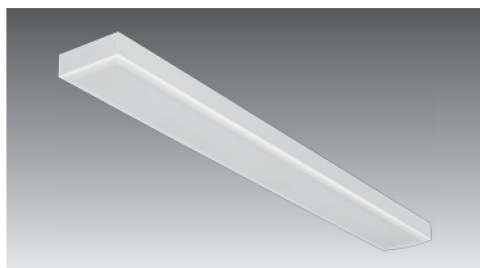

Varenr.	Produktnavn	Watt (W)	Lumen (lm)	Dimension (mm)	Lysvinkel (°)	Farve temp. (K)	Levetid (timer)	Dæmpbar	EAN kode
● 569118	D2PRZA	36	2600	L1210 x B140 x H55	120	3000	50000	Nej	6435200200013
● 569119	D2PRZA - DIM	36	2600	L1210 x B140 x H55	120	3000	50000	DIM1-10V	N/A
● 569120	D2PRZA - DALI	36	2600	L1210 x B140 x H55	120	3000	50000	DALI	N/A
● 569121	D2PRZG	60	4000	L1510 x B140 x H55	120	3000	50000	Nej	6435200200037
● 569122	D2PRZG - DIM	60	4000	L1510 x B140 x H55	120	3000	50000	DIM1-10V	N/A
● 569123	D2PRZG - DALI	60	4000	L1510 x B140 x H55	120	3000	50000	DALI	N/A

PROFI L Armatur

- Indbygget LED
- Lysdæmpningsmulighed med 1-10V / DALI
- Universal allround armatur til overflademontage eller wire-ophæng
- Stålkabinet
- Højeffektiv reflektor
- Leveres som standard med driver uden dæmp (569112 + 569115)

PROFI ZL Armatur

- Indbygget LED
- Lysdæmpningsmulighed med 1-10V / DALI
- Universal allround armatur til overflademontage eller wire-ophæng
- Stålkabinet
- Højeffektiv reflektor
- Leveres som standard med driver uden dæmp (569118 + 569121)



LED Påbygningsarmatur

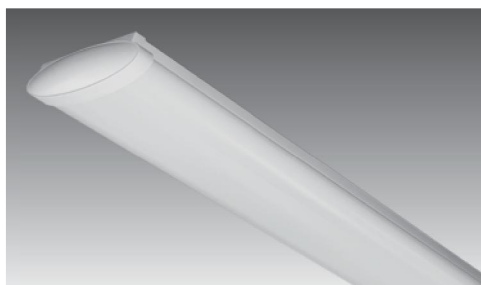

IP44 Klasse I Hvid

Varenr.	Produktnavn	Watt (W)	Lumen (lm)	Dimension (mm)	Lysvinkel (°)	Farve temp. (K)	Levetid (timer)	Dæmpbar	EAN kode
● 569163	D3KEAG	IP44 40	4400	L1293 x B208 x H77	120	3000	50000	Nej	6435200200631
● 569164	D3KEAG - DIM	IP44 40	4400	L1293 x B208 x H77	120	3000	50000	DIM1-10V	N/A
● 569165	D3KEAG - DALI	IP44 40	4400	L1293 x B208 x H77	120	3000	50000	DALI	N/A

KETO Armatur m/integreret LED

- Super effektivt LED armatur (110lm/w)
- Indbygget LED
- Tænder med det samme på 100% lysstyrke
- Velegnet til lysstyring
- Gennemgående ledningsføring 3 x 2,5 mm²

Påbygningsarmatur til T5 rør

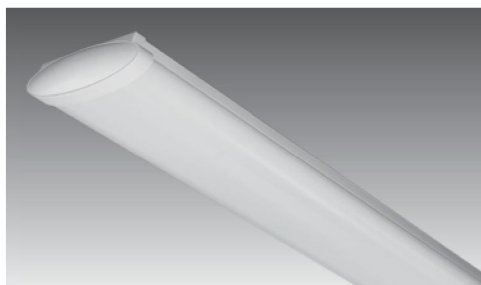

IP44 Klasse I Hvid

Varenr.	Produktnavn	Watt (W)	Dimension (mm)	Lysvinkel (°)	Dæmpbar	EAN kode
● 569134	D3KEAA	28	L1293 x B208 x H77	120	Nej	6435200200570
● 569135	D3KEAB	35	L1593 x B208 x H77	120	Nej	6435200200587
● 569136	D3KEAC	49	L1593 x B208 x H77	120	Nej	6435200200594
● 569137	D3KEAD	2 x 28	L1293 x B208 x H77	120	Nej	6435200200600
● 569138	D3KEAE	2 x 35	L1593 x B208 x H77	120	Nej	6435200200617
● 569139	D3KEAF	2 x 49	L1593 x B208 x H77	120	Nej	6435200200624

For T5 rør - se side 36

KETO Armatur T5

- Industriarmatur til alsidige løsninger
- Til overflademontage eller Wire-ophæng
- Bruges blandt andet til parkeringshuse, våde områder, værksteder mv.
- Leveres uden lysrør



RENZO LED armatur

- Effektiv erstatning for PL-rør armaturer, 1x18W og 1x26W
- Diskret og enkelt design til væg- og loftmontage
- IP44 certificeret til fugtige og våde områder
- Kan fås med bevægelsessensor
- Opal PMMA afskærmning for jævn fordeling af lyseffekt og behagelig belysning

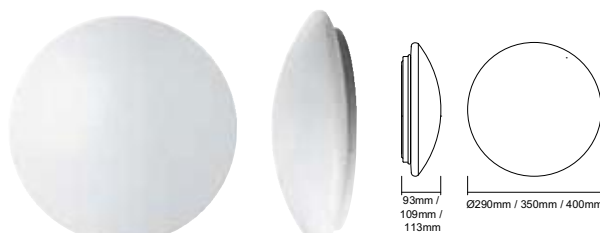

220-240V 50/60 Hz IP44 Class I Hvid

Varenr.	Produkt navn	Watt (W)	Lumen (lm)	Dimension (mm)	Klassificering	Lysvinkel (°)	Farve temp. (K)	Levetid (timer)	EAN kode / MM nummer
573563	F50800SM IP44	10.5	800	Ø290 x H93	IP44	110	3000	25000	4892657 060454
573564	F50900SM IP44	14.5	1100	Ø350 x H109	IP44	110	3000	25000	4892657 060461
573566	F53000SM IP44	15.5	1100	Ø350 x H109	IP44	110	3000	25000	4892657 060485
573565	F51000SM IP44	18.5	1400	Ø400 x H113	IP44	110	3000	25000	4892657 060478

Med bevægelses sensor

FONDA udendørs LED armatur

- Effektiv erstatning for PL-rør armaturer
- Til væg- og loftmontage
- UV resistent og IK10 certificeret for sikring mod hærværk
- IP66 beskyttelse mod vand og støv
- Kabinettet udarbejdet i Polycarbonat

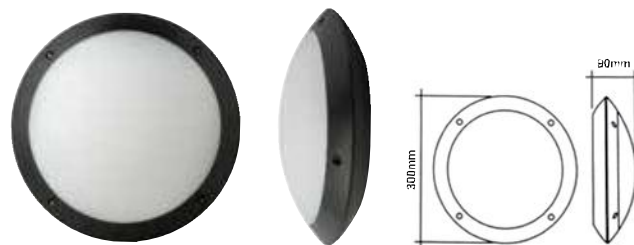

220-240V 50/60 Hz IP66 IK10 Class II Hvid Sort

Varenr.	Produkt navn	Watt (W)	Lumen (lm)	Dimension (mm)	Klassificering	Lysvinkel (°)	Farve temp. (K)	Levetid (timer)	EAN kode / MM nummer
574144	F51100SM - sort	10.5	800	Ø300 x H90	IP66	110	3000	25000	4892657 054316
574145	F51100SM - hvid	10.5	800	Ø300 x H90	IP66	110	3000	25000	4892657 052886

LUMI væg-/loftarmatur med indbygget LED

- Effektiv erstatning for CFL armaturer
- Tilkoblingsplint 3x2,5mm²
- IP44 version til fugtige områder og vådrum. Indbygget Radar bevægelses-sensor
- Enkelt og diskret design, til væg- eller loftmontering. Leveres med eller uden Dekorationsring



IP44 Klasse II Hvid

Varenr.	Produkt navn	Watt (W)	Lumen (lm)	Dimension (mm)	Lysvinkel (°)	Farve temp. (K)	Levetid (timer)	EAN kode
569024	LUMI Radar	6	480	Ø250 x H80	110	3000	50000	6435200187666
569026	LUMI	6	480	Ø250 x H80	110	3000	50000	6435200187581
569027	LUMI Radar	12	1000	Ø320 x H83	110	3000	50000	6435200187673
569028	LUMI	12	1000	Ø320 x H83	110	3000	50000	6435200187611
569025	Dekoring - LUMI 6W							6435200187727
569029	Dekoring - LUMI 12W							6435200187734

RONDA KUBO



RONDA armatur med indbygget LED

- Integreret LED
- Til væg- eller loftmontage
- Dæmpbar
- Kabinet udført i aluminium
- Tilkoblingsplint 3x2,5mm²
- Lav indbygningshøjde på kun 35mm
- Elegant design

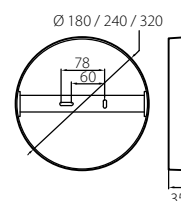

Klasse II Hvid

Varenr.	Produktnavn	Watt (W)	Lumen (lm)	Dimension (mm)	Lysvinkel (°)	Farve temp. (K)	Levetid L70 (timer)	Dæmpbar	EAN kode
569155	RONDA MINI	10	700	Ø180 x H35	90	3000	50000	Ja	6435200182289
569023	RONDA MIDI	15	1050	Ø240 x H35	90	3000	50000	Ja	6435200182296
569156	RONDA STOR	21	1500	Ø320 x H35	90	3000	50000	Ja	6435200187505

KUBO armatur med indbygget LED

- Integreret LED
- Til væg- eller loftmontage
- Dæmpbar
- Kabinet udført i aluminium
- Tilkoblingsplint 3x2,5mm²
- Lav indbygningshøjde på kun 35mm
- Elegant design

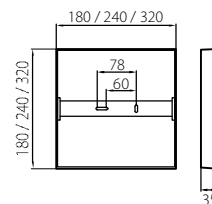

Klasse II Hvid

Varenr.	Produktnavn	Watt (W)	Lumen (lm)	Dimension (mm)	Lysvinkel (°)	Farve temp. (K)	Levetid L70 (timer)	Dæmpbar	EAN kode
569157	KUBO MINI	10	700	L180 x B180 x H35	90	3000	50000	Ja	6435200182319
569158	KUBO MIDI	15	1050	L240 x B240 x H35	90	3000	50000	Ja	6435200182326
569159	KUBO STOR	21	1500	L320 x B320 x H35	90	3000	50000	Ja	6435200187512

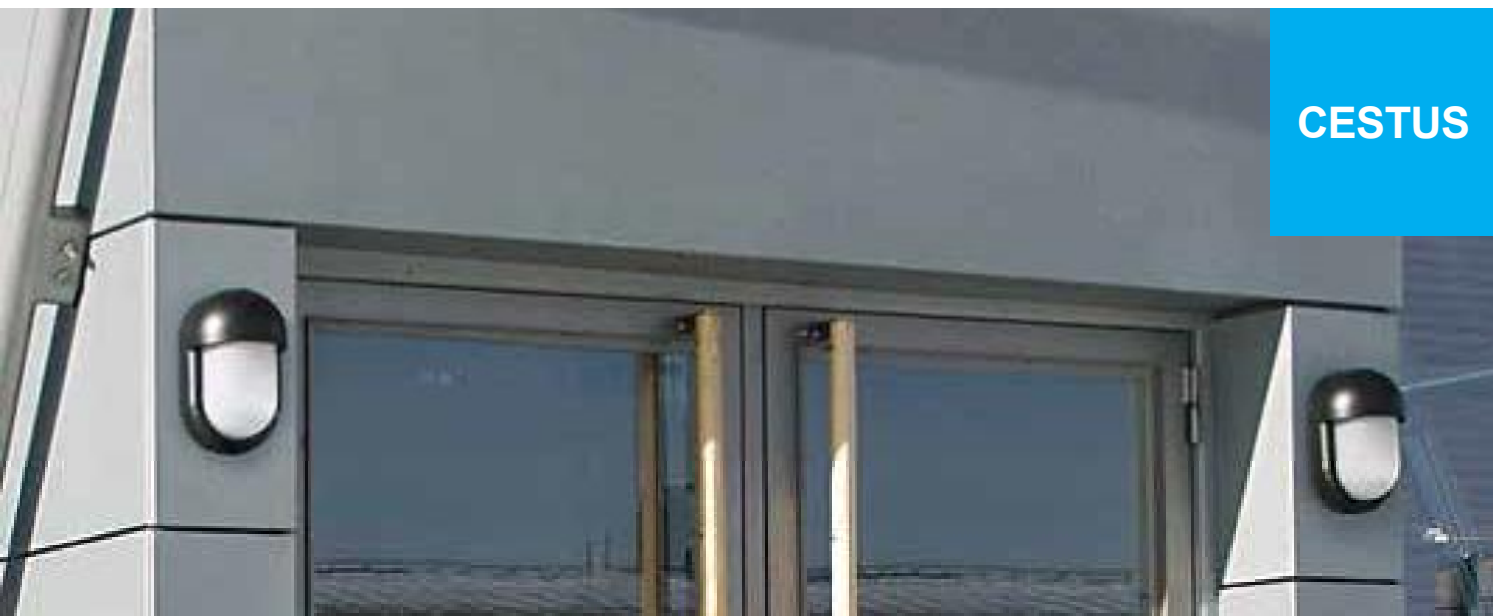

Varenr.	Produktnavn	Sokkel	Dimension (mm)	Vægt	EAN kode
569006	CESTUS Rondo - sort	E27	D155 x Ø260	2900	6435200163363
569007	CESTUS Rondo - sølv	E27	D155 x Ø260	2900	6435200163370
569008	CESTUS Rondo - hvid	E27	D155 x Ø260	2900	6435200163387
569011	CESTUS Rondo - sort	E27	D175 x Ø260	2900	6435200111975
569012	CESTUS Rondo - sølv	E27	D175 x Ø260	2900	6435200111982
569013	CESTUS Rondo - hvid	E27	D175 x Ø260	2900	6435200111439

Aluminium. Leveres uden lyskilde



Varenr.	Produktnavn	Sokkel	Dimension (mm)	Vægt	EAN kode
569020	CESTUS Oval P - sort	E27	H270 x L165	1900	6435200112026
569021	CESTUS Oval P - sølv	E27	H270 x L165	1900	6435200112033
569022	CESTUS Oval P - hvid	E27	H270 x L165	1900	6435200112422
569017	CESTUS Oval V - sort	E27	H270 x L165	1900	6435200112002
569018	CESTUS Oval V - sølv	E27	H270 x L165	1900	6435200112019
569019	CESTUS Oval V - hvid	E27	H270 x L165	1900	6435200112415

Aluminium. Leveres uden lyskilde

Tilbehør Cestus

Varenr.	Produktnavn	Vægt	EAN kode
569009	CESTUS Navne-/nummerplade - grå	100	6435200163424
569010	CESTUS Navne-/nummerplade - hvid	100	6435200160874

ARTE indendørs væglamper

- Keramisk væglampe med indbygget LED
- Overfladen kan males i passende farve til interiør

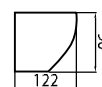
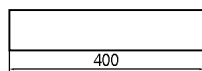

Klasse II Hvid

Varenr.	Produkt navn	Watt (W)	Lumen (lm)	Dimension (mm)	Lysvinkel (°)	Farve temp. (K)	Levetid (timer)	Dæmpbar	EAN kode
569160	A1AFAD	13	800	L400 x B122 x H75	45	3000	30000	Nej	6435200188342
569161	A1AFCD	13	800	L165 x B165 x H165	45	3000	30000	Nej	6435200188359
569162	A1AFBC	13	800	L245 x B122 x H90	45	3000	30000	Nej	6435200188451

ARTCO Plantelampe

- Elegant og tidløs plantebelysning med afbryder
- Vækstfremkaldende for planter



Hvid

Varenr.	Produkt navn	Sokkel	Watt (W)	Dimension (mm)	Vægt (g)	Levetid (timer)	EAN kode / MM nummer
169975	Plantelampe, inkl. lyskilde	E27	14	D174 x H220	300	10000	4020856221516
169265	Plantelys lyskilde	E27	15	D49 x H154	66	10000	6435200179128

Bemærk: Kan også leveres i LED-version

TOTT LED FLOODLIGHT



F25400SM

F25600SM

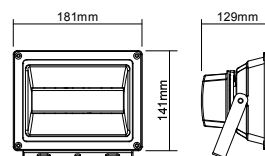
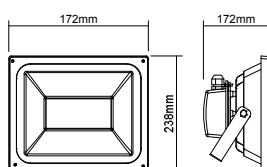
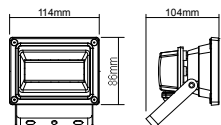
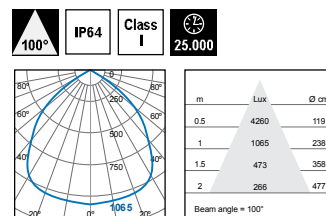
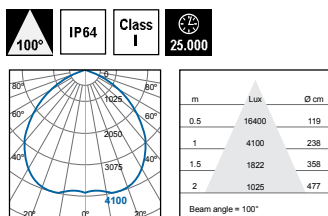
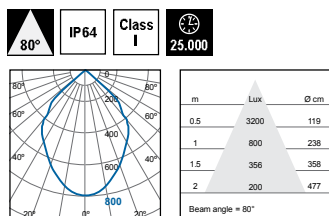

- Velegnet til udendørs belysning
- Pladsbelysning
- Indbygget LED, velegnet til bevægelsessensor
- IP64



Varenr.	Produktnavn	Watt (W)	Farve temp. (K)	Lumen (lm)	Dimension (mm)	Lysvinkel (°)	EAN kode / MM nummer
574128	F25500SM	12	3000	900	H86 x L115 x D77	100	4892657042672
574129	F25400SM	33	3000	2300	H141 x L181 x D102	100	4892657042689
574131	F25600SM	60	3000	4200	H235 x L287 x D134	100	4892657042622

FUTURA MARINA



FUTURA med integreret LED

- Indbygget kvalitets LED
- Stor effektivitet, op til 120lm/W
- Materiale: Polycarbonat med stålclips
- Kan benyttes i kolde omgivelser, -25 > +45°
- Tænder med det samme med fuld lysstyrke
- Gennemgående 5x2,5mm² ledningsføring
- Anvendes i fryse-/køleområder, parkeringshuse, lagerbygninger mv.



220-240V	50/60 Hz	IP66	Klasse I	IK08
----------	----------	------	----------	------

Varenr.	Produktnavn	Watt (W)	Lumen (lm)	Dimension (mm)	Lysvinkel (°)	Farve temp. (K)	Levetid (timer)	Dæmpbar*	EAN kode
569124	T3FUZA	28	3200	L1272 x B95 x H100	90	4000	50000	Nej	6435200187161
569125	T3FUZB	35	4000	L1272 x B95 x H100	90	4000	50000	Nej	6435200187178
569126	T3FUZC	43	5000	L1572 x B95 x H100	90	4000	50000	Nej	6435200187185
569127	T3FUZD	56	6400	L1272 x B145 x H100	90	4000	50000	Nej	6435200187192
569128	T3FUZE	69	7800	L1272 x B145 x H100	90	4000	50000	Nej	6435200187208
569129	T3FUZF	86	9800	L1572 x B145 x H100	90	4000	50000	Nej	6435200187215

* Dæmp med 1-10V / DALI er bestillingsvare

MARINA T8

- Velegnet armatur for LED T8
- Materiale: Polycarbonat med stålclips
- Kan benyttes i kolde omgivelser, -25 > +45°
- Gennemgående 5x2,5mm² ledningsføring
- Anvendes i parkeringshuse, værksteder, udendørsbelysning mv.
- Leveres uden lyskilde



220-240V	50/60 Hz	IP66	Klasse I
----------	----------	------	----------

Varenr.	Produktnavn	Watt (W)	Dimension (mm)	Lysvinkel (°)	EAN kode
569130	T3MARE	36	L1272 x B95 x H100	100	6435200158499
569131	T3MASE	58	L1572 x B95 x H100	100	6435200158512
569132	T3MATE	2 x 36	L1272 x B95 x H100	100	6435200158536
569133	T3MAUE	2 x 58	L1572 x B145 x H100	100	6435200158550

For T8 lysstofrør - se side 36. For Megaman® LED-rør, side 23
Kan skaffes med T5 lysstofrør, som er bestillingsvare.

MAXILUX stål armatur T5

- Velegnet til større loftshøjder
- Reflektor i hvid højglans
- Overflademontering eller wire-ophæng
- Stor effektivitet
- Anvendes i lagerbygninger, værksteder, fabrikshaller, industribygninger mv.
- Leveres uden lysrør



220-240V 50/60 Hz IP66 Klasse I Hvid

Varenr.	Produktnavn	Watt (W)	Dimension (mm)	EAN kode
569140	D3MMBA	24	L584 x B150 x H95	6435200161918
569141	D3MMCB	28	L1184 x B150 x H95	6435200161802
569142	D3MMDB	35	L1484 x B150 x H95	6435200161819
569143	D3MMEB	49	L1484 x B150 x H95	6435200161826
569144	D3MMGB	80	L1484 x B150 x H95	6435200161840
569145	D3MMIA	2 x 24	L584 x B150 x H95	6435200161932
569146	D3MMJB	2 x 28	L1184 x B150 x H95	6435200161857
569147	D3MMKB	2 x 35	L1484 x B150 x H95	6435200161864
569148	D3MMLB	2 x 49	L1484 x B150 x H95	6435200161871
569149	D3MMMB	2 x 54	L1184 x B150 x H95	6435200161888
569150	D3MMNB	2 x 80	L1484 x B150 x H95	6435200161895

For T5 lysstofrør - se side 36. Alle Maxilux armaturer er bestillingsvarer.

DINO vandsikkert LED integreret armatur, 220-240v

Med IP66 tætningsklasse, er her et lysarmatur til alle formål inde og ude, men især velegnet til udendørsbrug eller områder med f.eks støv og andet. Et godt alternativ til T5 og T8 armaturer.

- IP66 tætningsklasse
- IK08 beskyttelsesklasse
- Produceret i robust polycarbonat incl. prismeoptimeret diffuserglas
- UV modstandsdygtigt og rustsikkert
- Simpel installation og vedligeholdelse
- Velegnet til skibe, garageanlæg, lagerbygninger, gårde, produktionslokaler, værksteder m.v
- Levetid: 50.000 timer = ca. 10 år ved dagligt 12 timers tændingstid



220-240V 50/60 Hz IP66 IK08 Class II

Varenr.	Produktnavn	Watt (W)	Dimension (mm)	Levetid (timer)	EAN kode
573560	F50100SMv1 IP66	25.5	L1300 x B67 x H56	50000	4892657055726
573561	F50100SM IP66 High Output	46	L1300 x B67 x H56	50000	4892657055733
573562	F50200SM IP66 	48	L1300 x B67 x H68	50000	4892657055740

 Med bevægelses sensor

LUSTER

LUSTER High Bay LED industriarmatur

- Aluminium reflektor
- Store besparelser
- Tænder med det samme med 100% lysstyrke
- Længere levetid
- Stor effektivitet, 100lm/W
- Afløser HQI 150W, 250W and 400W High Bay
- Anvendes til fabrikshaller, lagerbygninger, værksteder, sportshaller mv.

F53200SU

150W HQI
Erstatning

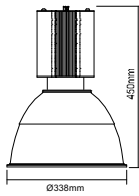

F52400SU

250W HQI
Erstatning

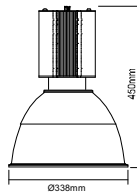

F53300SU

400W HQI
Erstatning

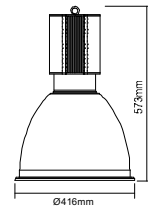

220-240V 50/60 Hz IP65 Class II Silver

Varenr.	Produkt navn	Watt (W)	Lumen (lm)	Dimension (mm)	Lysvinkel (°)	Farve temp. (K)	Levetid (timer)	EAN kode
574140	F53200SU IP65	70	6500	D338 x H450	60	4000	50000	4892657054019
574141	F52400SU IP65	110	11000	D338 x H473	60	4000	50000	4892657052978
574142	F53300SU IP65	210	21000	D338 x H573	60	4000	50000	4892657054026

Alle Luster armaturer er bestillingsvarer.



Lyon



Genua



Odense



Orca



Tellus

Vej- og parkbelysning

Varenr.	Produkt navn	Sokkel	Farve	Dimension (mm)
910008	LYON	E27	Mørk grå	H540 x B750
910009	GENUA	E27	Mørk grå	H400 x B738
910010	ODENSE	E27	Mørk grå	H450 x B570
910011	ORCA	E27	Lys grå	H165 x L550 x B240
910012	TELLUS	E27	Lys grå	Ø36
910015	Mistral Mini LED	Integreret LED	Lys grå	H145 x L555 x B255



Mistral Mini LED



- Højeffektive kvalitets LED armaturer til vej- og sti-belysning.
- Alle armaturer leveres med 10m FQQ 3G1.5q halogenfri kabel
- Leveres uden lyskilde
- Montagehøjde 2,5 - 18m
- Effekt fra 20W - 240W
- Mange muligheder for lysstyring
- Kontakt os for yderligere information

KONVERTERINGSTABEL ELSPAREPÆRER (CFL) TIL LED



Varenr.	Produktnavn	Sokkel	Watt	Varenr.	Produktnavn	Watt
172222	BR0707i	GU10	7	178207	LR1204dGv2-VWFL	4
172224	BR0711i	GU10	11	178209	LR1206dDGv2-VWFL	6
172226	BR2911	GU10	11			



Varenr.	Produktnavn	Sokkel	Watt	Varenr.	Produktnavn	Watt
172200	BR0907i	E14	7	178313	LR2603.5-SWFL	3.5
172201	BR0911i	E14	11			



Varenr.	Produktnavn	Sokkel	Watt	Varenr.	Produktnavn	Watt
172201	BR1111i E27	E27	11	178314	LR2407.5-SWFL	7.5



Varenr.	Produktnavn	Sokkel	Watt	Varenr.	Produktnavn	Watt
172203	BR1215i	E27	15	178348	LR4307-SWFL	7



Varenr.	Produktnavn	Sokkel	Watt	Varenr.	Produktnavn	Watt
172505	BR0623	E27	15	178322	LR3215.5-WFL	15.5



Varenr.	Produktnavn	Sokkel	Watt	Varenr.	Produktnavn	Watt
175504	BR2315i	E27	15	178321	LR3012-WFL	12



Varenr.	Produktnavn	Sokkel	Watt	Varenr.	Produktnavn	Watt
172160	4U107i	GU9	7	178222	LU0303d	2
172161	4U109i	GU9	9	178217	LU0104d	4



Varenr.	Produktnavn	Sokkel	Watt	Varenr.	Produktnavn	Watt
172145	WL218d	E27	18	178362	LG3713d	13
172148	GK715d	E27	15	178204	LG2310.5d	10.5



Varenr.	Produktnavn	Sokkel	Watt	Varenr.	Produktnavn	Watt
172070	GA805i	E14	5	178301	LG2603.5	3.5
172075	GA805i	E27	5	178302	LG2603.5	3.5

Produktionen af Elsparepærer udfases hastigt i takt med udviklingen af LED lyskilderne. Således vil også Mega-man® Elsparer lyskilder blive erstattet løbende af LED varianter og her er en konverteringsliste, der anviser hvad man kan erstatte med:



Varenr.	Produktnavn	Sokkel	Watt	Varenr.	Produktnavn	Watt
172071	GA807i	E14	7	178227	LG1405dv2	3.5
172050	CT0107i	E14	7			
172077	GA809i	E14	9	178343	LG5205.5	5.5
172052	CT0109i	E14	9			



Varenr.	Produktnavn	Sokkel	Watt	Varenr.	Produktnavn	Watt
172076	GA807i	E27	7	178265	LG1405dv2	5
172051	CT0107i	E27	7			



Varenr.	Produktnavn	Sokkel	Watt	Varenr.	Produktnavn	Watt
172114	GA809i	E27	9	178344	LG5205.5	5.5
172053	CT109i	E27	9			



Varenr.	Produktnavn	Sokkel	Watt	Varenr.	Produktnavn	Watt
172114	GA909i E27	E27	9	178304	LG2205.5	5.5
172054	CT0211 E27	E27	11	178347	LG4405.5	5.5
172461	GSU109 E27	E27	9	178304	LG2205.5	5.5
172462	GSU111 E27	E27	11	178347	LG4405.5	5.5



Varenr.	Produktnavn	Sokkel	Watt	Varenr.	Produktnavn	Watt
172112	GA913i	E27	13	178304	LG2205.5	5.5
				178305	LG2509.5	9.5
172113	GSU218i	E27	18	178305	LG2509.5	9.5
				178306	LG2311	11



Varenr.	Produktnavn	Sokkel	Watt	Varenr.	Produktnavn	Watt
172151	CL707i/CS/SE	E14	7	178225	LC0505dv2 E14	5
172154	CL709i/CS/SE	E14	9	178360	LC1105.5 E14	5.5
172463	CL405CS/SE	E14	5	178300	LC0403.5 E14	3.5



Varenr.	Produktnavn	Sokkel	Watt	Varenr.	Produktnavn	Watt
172254	GSU623	E27	23	178349	LG5013d	13

Find inspiration i en verden af lys

Scan koden eller download på megaman.dk

Megaman kataloger



Megaman
belysningskatalog



Megaman
komplet engelsk udgave
af LED programmet



Megaman
Kommende
produktnyheder



Megaman
Butiksbelysning



Megaman
Inspirationskatalog



Airam kataloger



Airam
Professionel
belysning



Airam
HOME katalog



Airam Jui- og
dekorations-
belysning



Øvrige kataloger



STRIHL
Vej- og park
belysning



Segula
Filament LED





Stort program af LED armaturer



IMPO  TRADING



Life in Light

MEGAMAN®